



A miner's shift: Coal face drilling

APERCC Coal Report

2023

PUBLISHED BY:

Asia Pacific Energy Research Centre (APERC)
Inui Building, Kachidoki 11F, 1-13-1 Kachidoki
Chuo-ku, Tokyo 104-0054 Japan

Tel: (813) 5144-8551

Fax: (813) 5144-8555

E-mail: master@aperc.or.jp (administration)

Website: <https://aperc.or.jp>

Cover photo: Thong Nhat Coal Mine, Viet Nam

©2023 Asia Pacific Energy Research Centre

How to cite this report

APERC (2023). *APERC Coal Report 2023*. Asia Pacific Energy Research Centre. Available for download from https://aperc.or.jp/reports/fossil_fuel_report.php

Foreword

APEC members with mature economies in North America, Northeast Asia, and Oceania are expected to reduce coal use in the power and industrial sectors substantially. However, APEC members with emerging and developing economies, such as China and Southeast Asia, may still rely on coal to meet a portion of their growing demand for electricity due to the affordability and reliability of coal supply.

The global trading flow has recently shifted, with Indonesia's thermal coal exports growing, Russia facing a significant reduction in coal exports due to sanctions, and Australia's production declining due to floods. Record-high coal prices in 2022, driven by economic recovery and geopolitical tensions, highlight the volatility in the coal market.

The APERC Coal Report 2023 covers key aspects of the coal sector, namely coal consumption, production, trade, prices, and coal-related policies amid turbulent years in the global coal market. This report introduces greenhouse gas emissions from the whole coal value chain for the first time.

Furthermore, this year's report examines the potential for technologies to assist in decarbonising coal-based power and industrial plants, such as thermal efficiency improvement, cofiring biomass/ammonia and coal, coal gasification, and carbon capture, utilisation and storage (CCUS). Particularly, CCUS technology is commonly referred to as a deep decarbonisation pathway for the large fleet of relatively young coal-fired power plants throughout APEC Southeast Asia economies and China.

This coal report is part of the APERC fossil fuel reports series, published annually to provide materials for discussion at the APEC Expert Group on Clean Fossil Energy (EGCFE) in particular and the APEC Energy Working Group (EWG) as a whole. I would like to express my sincere gratitude to the authors and contributors for their time and effort in writing and publishing this report. I am grateful to APEC member economies for providing updated data through the APEC Expert Group on Energy Data and Analysis (EGEDA) and supplying valuable comments.

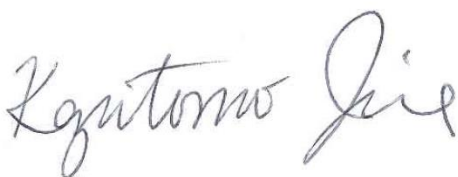

Dr Kazutomo IRIE
President
Asia Pacific Energy Research Centre

Acknowledgements

We would like to thank the APEC Expert Group on Energy Data and Analysis for supplying economy data. We also thank the administrative staff of APERC for their joint supportive role.

Authors and contributors

APERC:

- Phung Quoc HUY
- Glen E. SWEETNAM

Editors:

- Glen E. SWEETNAM
- Munehisa YAMASHIRO

Design:

- Phung Quoc HUY

Contents

Foreword	3
Acknowledgements	4
Contents	5
Abbreviations and Acronyms	7
List of Figures	8
List of Tables	9
Key highlights	10
Chapter 1: APEC coal policies and decarbonisation technologies	12
Recent coal policy developments	12
Decarbonisation technologies	16
Cofiring biomass and coal	16
Cofiring ammonia and coal.....	19
Thermal efficiency improvement.....	22
Coal gasification	24
Carbon Capture, Utilisation and Storage	27
Chapter 2: Coal consumption	29
World and APEC coal consumption	29
Thermal coal	35
Metallurgical coal	38
Chapter 3: Coal production	39
World and APEC coal production	39
Thermal coal	45
Metallurgical coal	46
APEC coal reserves	47
Chapter 4: Coal trade	48
APEC thermal coal trade	50
APEC metallurgical coal trade	52
APEC coal trade projections	54

Chapter 5: Prices and costs	56
Coal prices	56
Coal supply costs	58
Thermal coal production cost.....	59
Metallurgical coal production cost.....	60
Input factors influence supply costs	61
Chapter 6: Greenhouse gas emissions from the coal value chain	62
Carbon dioxide emissions	62
Methane emissions	65
References	71

Abbreviations and Acronyms

Abbreviations

AUD	Australian Dollar
CAD	Canadian Dollar
EJ	Exajoules
GW	Gigawatt
Gt	Gigatonne
Mt	Million tonnes
PJ	Petajoules
TWh	Terawatt hour
USD	US Dollar

Acronyms

ADB	Asian Development Bank
APEC	Asia-Pacific Economic Cooperation
APERC	Asia Pacific Energy Research Centre
BECCS	Bioenergy with Carbon Capture and Storage
CBM	Coalbed Methane
CCS	Carbon Capture and Storage
CCT	Clean Coal Technology
CCUS	Carbon Capture, Utilisation and Storage
CFB	Circulating Fluidized Bed
CFPP	Coal-Fired Power Plant
CH ₄	Methane Gas
CMM	Coal Mine Methane
CN	Carbon Neutrality Scenario
CO	Carbon Monoxide
CO ₂	Carbon Dioxide
COP26	The 26 th United Nations Climate Change Conference
CV	Calorific Value
EIA	U.S. Energy Information Administration
EOR	Enhanced-Oil-Recovery
EPA	U.S. Environmental Protection Agency
IEA	International Energy Agency
IGCC	Integrated Coal Gasification Combined Cycle
IGFC	Integrated Coal Gasification Fuel Cell Combined Cycle
NH ₃	Ammonia
REF	Reference Scenario
USC	Ultra-supercritical

List of Figures

Figure 1.1: Biomass cofiring technology options at coal-fired power plants.....	16
Figure 1.2: Development status in cofiring biomass and coal at selected APEC economies.....	17
Figure 1.3: Biomass cofiring at Guodian Jingmen coal-fired power plant, China.....	18
Figure 1.4: Development status in cofiring ammonia and coal at selected APEC economies.....	19
Figure 1.5: Demonstration of ammonia cofiring in existing Hekinan coal-fired power plant, Japan.....	21
Figure 1.6: Osaki CoolGen demonstration project, Japan.....	23
Figure 1.7: Coal gasification with CCUS.....	24
Figure 1.8: The hydrogen energy supply chain project between Australia and Japan.....	25
Figure 1.9: Coal-related CCS capacities in the APEC region.....	27
Figure 1.10: CCUS-equipped coal-fired power plant - The Boundary Dam, Canada.....	28
Figure 2.1: Coal consumption growth rate for the world and selected APEC economies.....	29
Figure 2.2: APEC coal consumption by region.....	30
Figure 2.3: Coal consumption in China, US, and Russia, 2012-2022.....	31
Figure 2.4: Coal consumption in Northeast Asia, 2012-2022.....	32
Figure 2.5: Coal consumption in Southeast Asia, 2012-2022.....	33
Figure 2.6: APEC coal consumption: history and outlook.....	34
Figure 2.7: APEC thermal coal (including lignite) consumption by economy: history and outlook.....	35
Figure 2.8: Coal share in the APEC generation mix.....	36
Figure 2.9: Thermal coal (including lignite) consumption in selected Southeast Asia economies.....	37
Figure 2.10: APEC metallurgical coal consumption by economy: history and outlook.....	38
Figure 3.1: Coal production growth rate for the world and selected APEC economies.....	39
Figure 3.2: APEC coal production by region.....	40
Figure 3.3: Coal production in China, US, and Russia, 2012-2022.....	41
Figure 3.4: Coal production in Southeast Asia, 2012-2022.....	42
Figure 3.5: Coal production in Oceania, 2012-2022.....	43
Figure 3.6: APEC coal production: history and outlook.....	44
Figure 3.7: APEC thermal coal (including lignite) production by economy: history and outlook.....	45
Figure 3.8: APEC metallurgical coal production by economy: history and outlook.....	46
Figure 3.9: APEC coal reserves and R/P ratio of the top five APEC coal producers, 2020.....	47
Figure 4.1: Change in thermal coal exports from major APEC coal exporters.....	48

Figure 4.2: Change in metallurgical coal exports from major APEC coal exporters.....	49
Figure 4.3: Thermal coal imports and proportion of thermal coal imports to thermal coal consumption	50
Figure 4.4: Thermal coal exports and proportion of thermal coal exports to thermal coal production	51
Figure 4.5: Metallurgical coal imports and proportion of metallurgical coal imports to metallurgical coal consumption.....	52
Figure 4.6: Metallurgical coal exports and proportion of metallurgical coal exports to metallurgical coal production.....	53
Figure 4.7: APEC coal imports: history and outlook.....	54
Figure 4.8: APEC coal exports: history and outlook	55
Figure 5.1: Newcastle benchmark thermal coal spot prices, January 2019 to December 2023	56
Figure 5.2: Australian premium hard coking coal spot price, January 2019 to December 2023	57
Figure 5.3: Mining cost structure.....	58
Figure 5.4: The share of high calorific value (CV) coal production by supply cost, 2019	59
Figure 5.5: The share of metallurgical coal production by supply cost, 2019	60
Figure 5.6: Average labour cost in main coal-producing economies in the APEC region, 2018-2020.....	61
Figure 6.1: Coal-related CO ₂ emissions in APEC and the rest of the world, 2011-2021.....	62
Figure 6.2: CO ₂ emissions from coal combustion in selected APEC economies in 2021	63
Figure 6.3: Coal-related CO ₂ emissions in China.....	64
Figure 6.4: Global methane emissions and sources of emissions, 2022	65
Figure 6.5: Sources of coal mine methane emissions	66
Figure 6.6: Coal mine methane emissions in the selected APEC economies, 2022.....	67
Figure 6.7: Coal mine methane emissions in China	68
Figure 6.8: Coal mine methane emissions in Indonesia	69
Figure 6.9: Coal mine methane emissions in Australia	70

List of Tables

Table 1.1: Current and planned measures to support decarbonising in coal combustion users

Table 1.2: Notable developments of coal policies in APEC economies

Table 1.3. Thermal efficiency in different coal power technology

Key highlights

Global coal consumption reached an all-time high in 2022 at 161.5 EJ. The surge in demand was caused by disruptions in global fossil fuel supplies and trade flows, which caused very high liquefied natural gas prices and switching to coal. In the APEC region, coal consumption followed the global trend, rising in 2022 despite slower economic growth in China, the largest coal consumer.

APEC economies are increasingly committed to decarbonising their power sector.

- Fifteen APEC economies are committed to achieving net-zero emissions or carbon neutrality targets by 2050, and China, Indonesia and Russia have pledged to attain the climate goal by 2060. Thailand is committed to reaching net zero emissions by 2065.
- Nine APEC economies signed the Global Coal to Clean Power Transition Statement at COP26, which commits to transitioning away from unabated coal power generation in the 2030s for major economies and in the 2040s globally.
- As of the end of 2023, most APEC economies committed to not building new coal-fired power plants and/or phasing down coal use.

Various decarbonisation technologies could become feasible for coal-based power and industrial plants.

- Feasible measures for reducing the carbon emissions associated with coal usage include two categories, namely: (1) applying decarbonising technologies such as thermal efficiency improvement, carbon capture, utilisation and storage (CCUS), and clean coal technology (CCT) and (2) enacting policies to phasing down coal usage and not building new coal power plants.
- Cofiring biomass or ammonia in existing coal-fired power plants can assist in reducing CO₂ emissions by lowering the amount of coal input. Many APEC economies have considered introducing these measures.
- Coal gasification is an other option to transform coal into synthetic gases which can be used in various sectors. Coal gasification associated with CCUS will be a near-zero CO₂ emissions technology, expected to be the lowest-cost source for large-scale hydrogen production in the near and medium term.
- Depending on the future costs of CCUS technologies, CCUS could potentially reduce the opportunity costs associated with the early retirement of coal-fired power plants. More APEC economies are exploring the feasibility of installing CCUS facilities at coal-fired power plants.

APEC-wide coal consumption rose slightly in 2022 but was not uniform across all economies.

- Coal consumption in China, the world's largest coal consumer, grew by approximately 1% in 2022. It was the lowest growth in coal consumption since 2018.
- Coal consumption in Indonesia rose sharply in 2022 due to high coal demand after the rebound in economic growth following the COVID-19 pandemic, the commissioning of new coal-fired power plants, and the expansion of the nickel industry.

- In the United States, coal consumption dropped by 6.6% compared to the previous year, returning to the declining trend in coal consumption, which has been seen in the last two decades.
- Coal consumption in Russia, Korea, and Japan declined by 7%, 5.6%, and 0.2%, respectively, in 2022 relative to the previous year.

APEC coal production rose 7.7% in 2022 compared to 2021, though the rising trend was not uniform across all economies.

- In China, the world's largest coal producer, coal production increased by 10.5% in 2022, the highest growth among APEC economies in response to the high demand for domestic coal usage.
- Indonesia's coal production rose 10% in 2022, the second-highest growth among APEC economies after China. The increased coal production was both for export and domestic use.
- The United States and Russia showed a slight increase in coal production by 3.9% and 1.1% in 2022, respectively.
- Coal production in Australia dropped by 3.6% in 2022 due to lower metallurgical coal exports.

Thermal coal exports from Indonesia grew in 2022, but exports from other APEC economies dropped.

- Indonesia increased coal exports by 37 Mt in 2022, a unique economy among APEC coal export economies with growth in thermal coal exports in 2022.
- Russia showed the largest drop in coal exports in 2022 (-17 Mt) due to international sanctions and coal import bans from Western economies.
- Australia's coal exports declined by 15 Mt in 2022 because of reduced production due to the floods in New South Wales and Queensland.

Coal prices reached a record-high level in 2022 due to the energy crisis and the Ukraine conflict.

- Thermal coal spot prices reached a record high in September 2022, reaching approximately USD 450 per tonne, a nine-time higher than in September 2020. In 2023, thermal coal spot prices dropped dramatically from USD 400 per tonne in early 2023 to around USD 130 per tonne in July.
- Metallurgical coal prices surged to an unprecedented level of about USD 630 per tonne in March and then fell to around USD 200 per tonne in June 2022. In 2023, coking coal prices fell during the first quarter and eased further in June as Australian supply picked up. The limited supply of Australian high-quality raw metallurgical coal explains the price increase for coking coal in the third quarter.

Chapter 1: APEC coal policies and decarbonisation technologies

Recent coal policy developments

As of December 2023, 19 APEC economies announced commitments to reach net-zero or carbon neutrality targets at a certain point in this century. While most economies plan to realise these commitments by 2050, China, Indonesia and Russia plan to achieve the goal by 2060. Thailand is committed to reaching net zero emissions by 2065 (Net Zero Tracker).

Several APEC economies have reduced or eliminated their proposed coal projects after signing “the Global Coal to Clean Power Transition Statement” at COP26 or joining the “No New Coal Power Compact”. At COP26, nine APEC economies signed the Global Coal to Clean Power Transition Statement, wherein they committed to rapidly scale up technologies and policies in this decade to achieve a transition away from unabated coal power generation in the 2030s or the 2040s, depending on each economy’s situation. These economies include Brunei Darussalam, Canada, Chile, Indonesia, Korea, New Zealand, the Philippines, Singapore, and Viet Nam.

APEC economies have different pathways to achieving their net-zero targets, depending on their economic strength, energy mix, and domestic energy resources. Advanced technologies, renewable energy, nuclear energy, and circular carbon economy have a significant role in many APEC economies. However, other APEC economies prioritise ensuring affordable and reliable energy supply sources. In the power sector, coal-fired power plants are still the first choice for several developing and emerging APEC economies due to reliable baseload characteristics.

In most APEC economies, switching from coal to cleaner or renewable energy is in progress. Fourteen economies have been improving thermal efficiency in coal-fired power plants to reduce coal consumption. While Australia, Canada, China, Indonesia, Japan and the United States are advancing CCS/CCUS technology in the coal-based plants, five additional economies (Korea, Malaysia, Chinese Taipei, Thailand and Viet Nam) have plans to deploy CCS/CCUS projects in the coming years. Twelve economies are utilising CCT for various purposes, while most economies committed to not building new coal-fired power plants or to phasing down coal use.

Table 1.1: Current and planned measures to support decarbonising in coal combustion users

Economies	Fuel switching	Thermal efficiency improvement	CCS/CCUS	CCT ¹	Phasing down or no new coal power
Australia	●	●	●	●	
Brunei Darussalam	●				●
Canada	●	●	●	●	●
Chile	●				●
China	●	●	●	●	
Hong Kong, China	●				●
Indonesia	●	●	●	●	●
Japan	●	●	●	●	●

¹ CCT (Clean Coal Technology) includes co-firing biomass/ammonia with coal, coal-to-gas, coal-to-liquid with carbon capture and storage, hydrogen/ammonia production from coal with carbon capture and storage.

Korea	●	●	●	●	●
Malaysia	●	●	●	●	●
Mexico	●	●			●
New Zealand	●				●
Papua New Guinea					●
Peru	●				●
Philippines	●	●			●
Russia	●	●		●	
Singapore	●				●
Chinese Taipei	●	●	●	●	●
Thailand	●	●	●	●	●
USA	●	●	●	●	●
Viet Nam	●	●	●	●	●

Source: compiled by the authors based on Boom and Bust Coal (2022), Global Energy Monitor, EGEDA, E3G (2022), and IEA (2023c).

Note: Hong Kong (China), Singapore, Peru, Brunei Darussalam, and New Zealand have small-scale coal pipelines, while Papua New Guinea is not using coal in its energy system.

Due to environmental and climate change pressures, financing for coal-fired generation projects has become more challenging in many APEC economies. A growing list of insurers, banks, and assets managers have made public statements indicating they will no longer support new coal-fired power plants or new thermal coal mines. In the APEC region, China, Japan, and Korea have played a significant role in financing coal-fired power plants, with Indonesia and Viet Nam being major recipients of this financing.

Table 1.2: Notable developments of coal policies in APEC economies

Economy	Notable developments
Australia	China allowed all domestic companies to import coal from Australia, ending trade restrictions that were first imposed in late 2020. The La Nina weather event brought heavy rain in 2022, disrupting Queensland and New South Wales coal production. A larger share of Australian coal is being diverted to Europe due to Russian sanctions.
Brunei Darussalam	Coal has been imported since 2019 to generate electricity and heat for Hengyi Industries' refinery and petrochemical complex in Pulau Muara Besar. Coal imports are expected to increase due to an increase in the size of the facility.
Canada	Coal will likely be phased out of its electricity mix well before the 2030 deadline. The federal Government's phase-out of thermal coal by 2030, together with its 2030 moratorium on thermal coal exports, will restrict thermal coal development over the coming decade. In October 2023, the Government of Canada has announced nearly CAD 20 million in federal funding to support the provinces of Nova Scotia and New Brunswick to help enable a phase-out of coal-fired electricity generation by 2030.
Chile	Almost 3.56 GW of coal-fired power plants will shut down before 2025. In 2022, the new government indicated its intention to accelerate the closure of coal-fired power plants and completely phase them out by 2030. However, the National Electricity Coordinator

requested that Bocamanina II, a coal-based power plant, extend its operations beyond its proposed closure date because of a megadrought that has stressed the electricity system. Chile launched the Just Transition Strategy, which contains measures to mitigate the social impact of the closure of coal-based power plants by transforming those areas into other uses, including green hydrogen production.

China	<p>The 14th FYP promotes the “clean and efficient use of coal” and no longer places a cap on coal-fired capacity or consumption. This is largely related to ensuring energy security. As a result, coal and coal-fired power reductions may take a more cautious pace, though President Xi stated in April 2021 that China would strictly limit the increase in coal consumption from 2021 to 2025 and phase it down from 2026 to 2030.</p> <p>Surging economic growth combined with international supply disruptions has seen large drawdowns of coal inventories in the latter half of 2021, leading to blackouts and industrial shutdowns.</p>
Hong Kong, China	<p>HKC plans to stop investing in coal-fired capacity additions now and to phase out coal by 2050.</p>
Indonesia	<p>Indonesia plans to stop developing new coal-fired power plants, except for projects that are already contracted or under construction and for projects integrated with industries oriented to increase the added value of natural resources. It plans to retire its older coal power generation early in its energy transition strategy. Indonesia also plans to implement cofiring for coal-fired power plants using biomass and producing dimethyl ether fuel from coal. Indonesia still implements the domestic market obligation policy for coal, though the domestic coal ceiling price mechanism is under review.</p> <p>At COP28, Indonesia agreed to shut the Cirebon-1 coal-fired power plant almost seven years earlier than planned under the ADB’s Energy Transition Mechanism program.</p>
Japan	<p>Japan aims to phase out inefficient coal-fired power plants. Japan committed no longer providing new state funding for overseas coal projects from the end of 2021 at the G7 summit in Cornwall. At COP28, Prime Minister Fumio Kishida pledged to take necessary measures to reduce Japan's reliance on coal-fired power generation, aiming to achieve its commitment to realizing carbon neutrality by 2050. Japan will terminate the construction of new coal-fired power plants.</p>
Korea	<p>The 3rd Energy Master Plan (2019) and the 9th Basic Plan on Electricity Demand and Supply (2020) commit to reducing coal and replacing it with renewables and natural gas. The recent draft of the 10th Basic Plan on Electricity Demand and Supply, released in August 2022, maintains the goal of reducing coal power generation within reasonable scope in consideration of the power situation. Meanwhile, Korea will no longer provide state support to new overseas coal projects.</p>
Malaysia	<p>Malaysia announced its “zero new coal-fired plants” commitment in September 2021 as part of the measures to achieve carbon neutrality by 2050.</p>
Mexico	<p>Original plans to phase out coal-fired generation by 2030 have been retracted, with coal-fired capacity now expected to remain at similar levels for the next decade. According to National Center for Energy Control (CENACE), coal use for electricity generation from CFE’s power plants increased in 2022 compared to 2021 levels.</p>

New Zealand	Thermal coal imports have surged in 2020 and 2021 due to lower hydro generation (lower-than-normal rainfall) and unexpectedly low natural gas supply.
Papua New Guinea	There is no production or consumption of coal in Papua New Guinea. However, there are tentative early-stage plans for coal-fired power plants to be built in multiple Papua New Guinea cities.
Peru	The 135 MW Ilo coal-fired power plant was already retired in 2022. Coal is mainly consumed in the cement industry and plays a minor role in the power sector.
Philippines	The Philippines Department of Energy has issued a moratorium (October 2020) on the endorsement of greenfield coal-fired power projects.
Russia	Russia's Energy Strategy to 2035 encourages domestic companies to increase production as well as expand coal exports throughout APEC. The 2035 Coal Strategy sets goals to increase production from new fields and improve profitability, safety, and pollution control.
Singapore	The Development Bank of Singapore became the first Singaporean bank to commit to a phase-out of coal exposure by 2039.
Chinese Taipei	It continues to be wholly reliant on thermal coal imports, with coal accounting for the largest share of the economy's electricity generation.
Thailand	The state-owned Electricity Generating Authority has shelved plans to build the 870 MW coal-fired plant in Krabi and the 2 200 MW coal-fired plant in Songkhla, favouring gas-fired facilities instead.
USA	The United States has not built a new coal plant in over a decade and is on track to close more than half of its peak unabated capacity in the next several years. The Biden Administration has committed to creating a carbon pollution-free power sector by 2035. The United States is also a committed supporter of countries worldwide looking to transition from coal through the Just Energy Transition Partnerships, the Energy Transition Accelerator and bilateral engagement and support.
Viet Nam	In the Power Development Plan (PDP8), coal-fired power plant capacity increases gradually to 30 GW by 2030, and no new coal-fired power plants will be built after 2030. Viet Nam plans to phase out coal in the power sector by 2050. At a COP28 side event, Viet Nam's prime minister Pham Minh Chinh has mapped out how Viet Nam aims to spend the \$15.5 billion pledged by G7 nations to boost the deployment of renewables and cut dependence on coal.

Decarbonisation technologies

Cofiring biomass and coal

Figure 1.1: Biomass cofiring technology options at coal-fired power plants

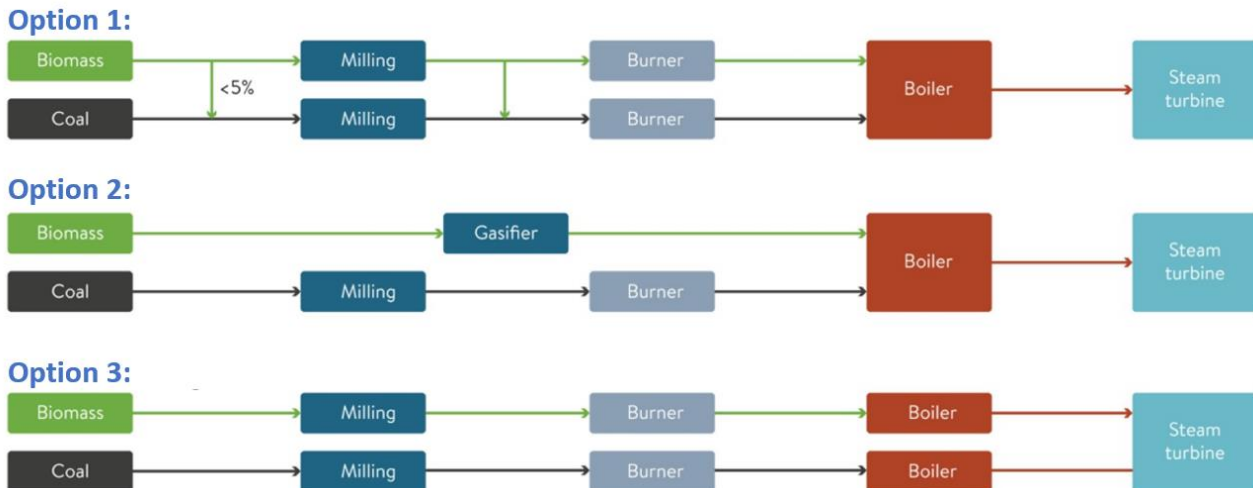

Sources: ICSC (2022).

Key points

- Cofiring biomass in existing coal-fired power plants can assist in reducing CO₂ emissions by lowering the amount of coal consumption as input fuel. This technology has been commercialised in Japan and Korea, while some other APEC Southeast Asia economies are approaching it to decarbonise their coal power fleets.
- There are three options for cofiring biomass at existing coal-fired power plants.
- In option 1, coal and biomass are cofired in the same boiler. Biomass is pre-mixed with coal in the existing coal handling and conveying system at modest cofiring ratios, then co-milled and cofired in the existing coal-firing system. In the case of using dedicated devices for biomass milling and burning, the biomass ratio can be increased up to 50% on an energy basis.
- In option 2, biomass is gasified in a separated biomass gasifier, and the fuel gas is burned with coal in the same coal boiler.
- In option 3, biomass and coal use separate millers, burners, and boilers. Subsequently, both steam sources are introduced to steam turbines for electricity generation.
- Both options 1 and 3 allow to cofire at high ratios of biomass and have greater fuel flexibility.
- In the APEC region, Japan and Korea are actively deploying biomass cofiring in the existing coal-fired power plants.

Figure 1.2: Development status in cofiring biomass and coal at selected APEC economies

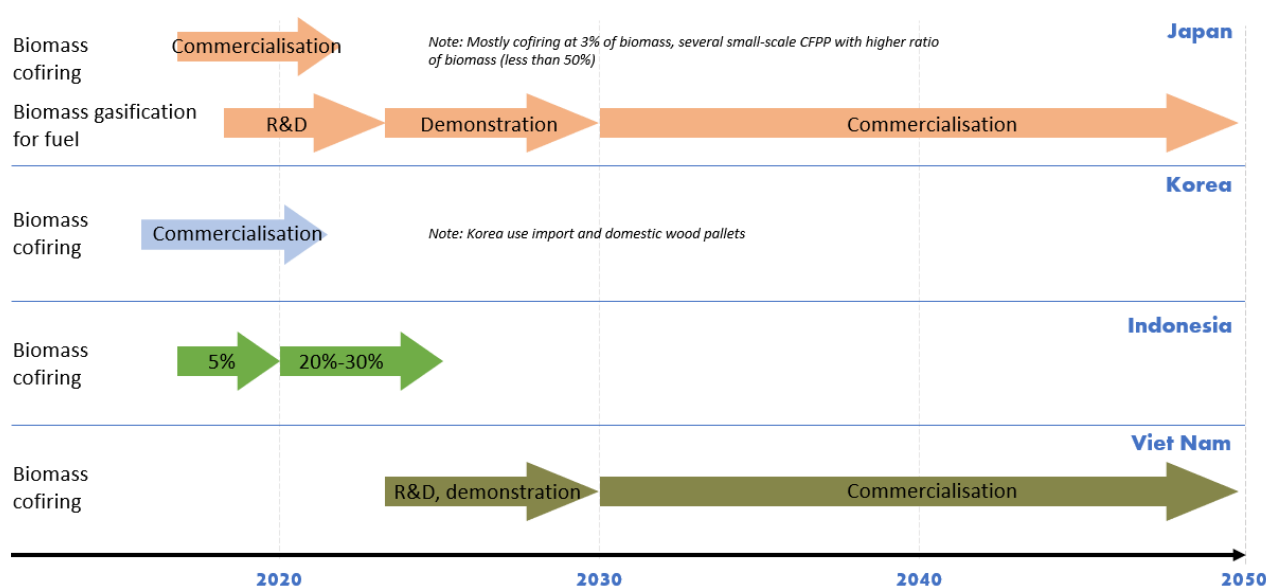

Sources: compiled by authors based on ERIA (2023), IEA (2023c), Mongabay (2022), PDP8 (2023).

Key points

- Japan has commercialised biomass cofiring in coal-fired power plants, initially supported by a feed-in tariff (FIT) policy to promote renewable energy. However, the biomass ratio is often less than 10%, except for some projects with special designs, which can introduce a higher biomass ratio. For instance, the Hofu biomass-coal cofiring power plant in Yamaguchi prefecture began commercial operation in July 2019 with a cofiring ratio of 50%. In 2019, Japan eventually removed biomass cofiring from its FIT scheme. However, the 38 certified biomass-coal cofiring generators continue to receive support for 20 years of their FIT contracts (Mongabay, 2022).
- Korea introduced the Renewable Portfolio Standard (RPS) in 2012, a system that mandates power generation business operators of 500 MW or more to supply a certain percentage of total power generation using renewable energy. Therefore, various biomass resources have been used to meet the RPS targets, including biomass cofiring in the existing coal-fired power plants. Since 2017, many coal-fired power plants in Korea have used biomass to cofire with coal as an input fuel. Two units of the KOSPO Green Power Plant in Sam Cheok operated in 2016 and 2017, with a 5% biomass cofiring ratio on an energy basis (ICSC, 2022). As of 2022, Korea has 44 cofired and 27 dedicated biomass generators and still uses biomass cofiring in its coal-fired power plants.
- In Indonesia, 13 coal-fired power plants had commercially implemented biomass cofiring by March 2021, at a 1% to 5% biomass ratio on an energy basis. Rice husks and sawdust waste were the most common biomass sources. The PLN, an Indonesian government-owned corporation, conducted cofiring tests with a 5% biomass at 32 of 52 coal-fired power plants. The PLN plans to increase its renewable share to 23% by 2025. Therefore, the biomass cofiring ratio will increase to 20% -30 % in the coming years (ERIA, 2023).
- Viet Nam issued a new Power Development Plan (PDP8) in May 2023, considering cofiring biomass in the existing coal-fired power plants after 2030. Coal-fired power owners are drafting a detailed roadmap for cofiring existing power plants with biomass.

Figure 1.3: Biomass cofiring at Guodian Jingmen coal-fired power plant, China

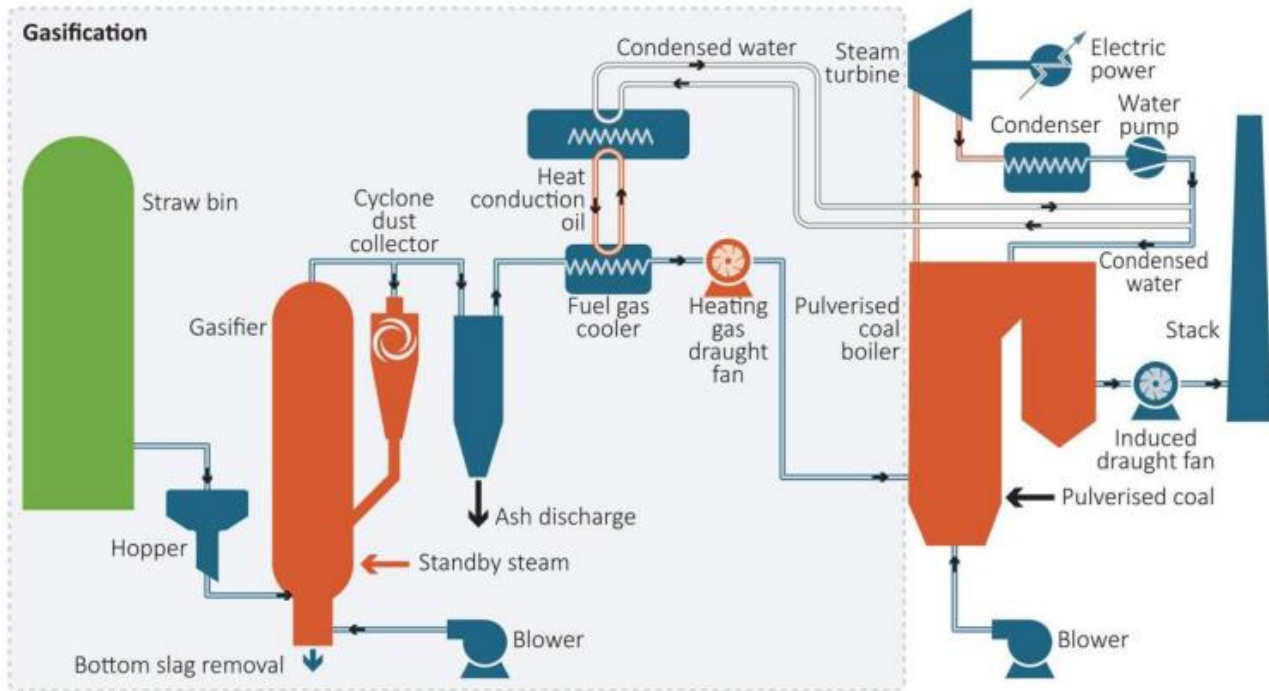

Source: Xing Zhang (2020).

Key points

- The Guodian Jingmen coal-fired power plant is located in Hubei province (China) and has an installed capacity of 600 MW. The plant was commissioned in 1983. Currently, the plant is owned by Guodian Jingmen Jiangshan Power.
- This coal-fired power plant runs on dual fuel. The primary fuel being used in this plant is bituminous coal. In case of a shortage of bituminous coal, the plant can also run on oil.
- Guodian Jingmen coal-fired power plant was the first biomass cofiring pilot test with a 10.8 MW gasifier in 2013. Rice straw was gasified with a gasification efficiency greater than 70%. The gas output was 14 000–18 000 m³/h, and the calorific value of the combustible gas was 4–5 MJ/m³.
- High-temperature gas was sent by the heating gas draught fan to be burnt in the pulverised coal boiler via two special gas burners on the two sides of the boiler after passing through the circulation separator, dust separator and heat exchanger for proper cooling.
- The same 10.8 MW gasifier design was applied to the 660 MW supercritical Unit 6 of Xiangyang coal-fired power plant (Hubei province, China), which became operational in September 2018. A larger CFB gasifier was coupled with a 600 MW supercritical unit at Datang Changshan coal-fired power plant (Jilin province, China) in December 2019.

Cofiring ammonia and coal

Figure 1.4: Development status in cofiring ammonia and coal at selected APEC economies

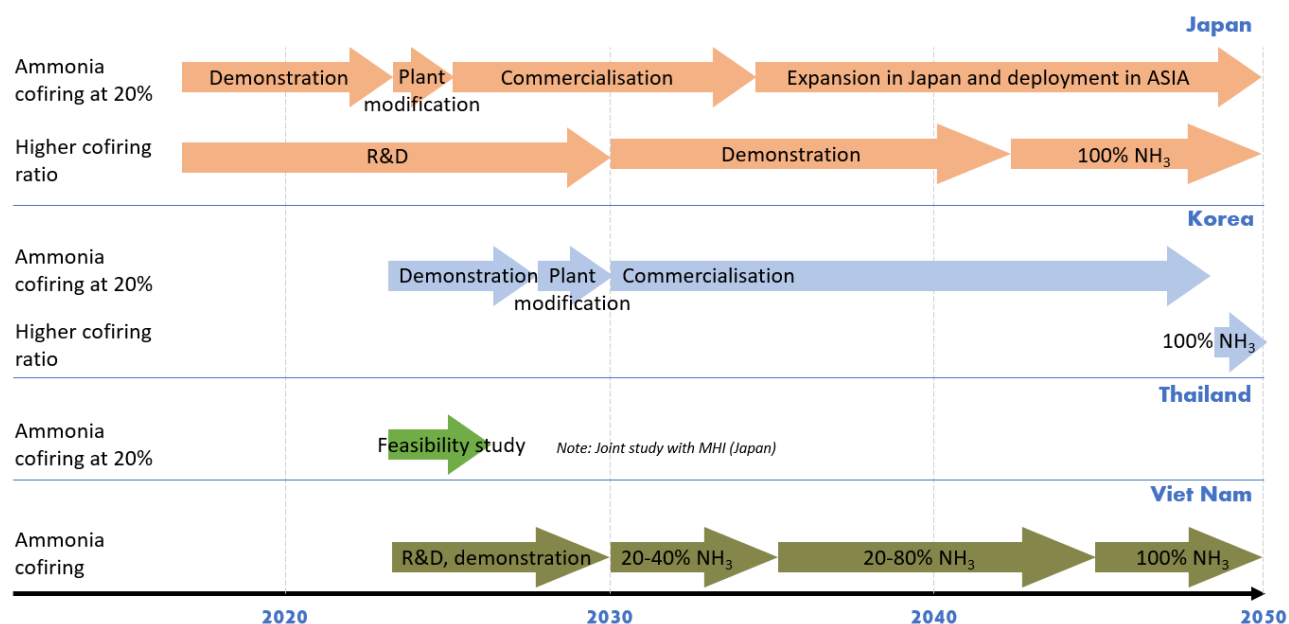

Sources: compiled by authors based on METI (2020), ERIA (2023), IEA (2023c), Mongabay (2022), PDP8 (2023), MHI (2023).

Key points

- Ammonia does not emit CO₂ when burning and is expected to have great potential in reducing CO₂ emissions from coal-burning users such as coal-fired power and coal-based industrial plants. Cofiring ammonia with coal at 20% has been tested and demonstrated in several coal-fired power plants in Japan.
- Ammonia has a well-developed infrastructure for a full supply chain, including production, transport, storage and use. Therefore, transporting ammonia by ship has a lower cost than hydrogen transport. This low transport cost is one of the main reasons several APEC Asia economies consider using ammonia for cofiring in existing coal-fired power plants.
- In Japan, cofiring ammonia in the existing USC coal-fired power plants is implemented at the demonstration phase with 20% of ammonia on an energy basis, aiming for practical application in the coming years. Furthermore, the Japanese government intends to spread 20% ammonia cofiring to the Asian region in the middle of the 2030s. At the same time, research and experimental tests of a higher cofiring ratio and dedicated ammonia firing technology are also underway.
- Korea plans to promote ammonia cofiring through technological development and demonstration with targets of 20% cofiring demonstration by 2027, 20% cofiring commercialisation by 2030 and 100% ammonia-fueled firing by 2050.
- Thailand aims to introduce ammonia cofiring technology into its existing coal-fired power plants. In 2023, Mitsubishi Heavy Industries (MHI) signed a Memorandum of Understanding to collaborate in a feasibility

study to introduce ammonia co-firing at a coal-fired thermal power plant operated by BLCP Power Limited².

- In addition to MHI and BLCP, several Thai and Japanese organizations are also involved in the project. MHI will conduct a study on the supply of ammonia burners, boiler facilities and equipment necessary for ammonia cofiring. JERA³ will examine the procurement and transportation of ammonia fuel, whereas JERA and Mitsubishi Corporation will investigate the port facilities, along with ammonia receiving and storage facilities. BLCP, MHI, Mitsubishi Corporation and JERA will also jointly conduct studies and develop plans to achieve up to 20% ammonia cofiring in coal-fired power plants (MHI, 2023).
- Viet Nam plans to deploy ammonia cofiring in the existing coal-fired power plants after 2030, starting from 20% of ammonia on an energy basis, targeting 100% of ammonia firing by 2045. To prepare for the ammonia supply, Viet Nam has started constructing a 200 MW electrolysis plant this year in Tra Vinh province, which will produce 150 000 – 180 000 tonnes of ammonia and 30 000 tonnes of green hydrogen per year and is expected to be operational in 2024.

² BLCP Power Ltd. is an independent power producer in Thailand and a joint-venture (50:50) between Banpu Power Public Company Limited and Electricity Generating Public Company Limited.

³ JERA is a 50-50 joint venture between TEPCO Fuel & Power, a wholly owned subsidiary of Tokyo Electric Power Company, and Chubu Electric Power, founded in April 2015

Figure 1.5: Demonstration of ammonia cofiring in existing Hekinan coal-fired power plant, Japan

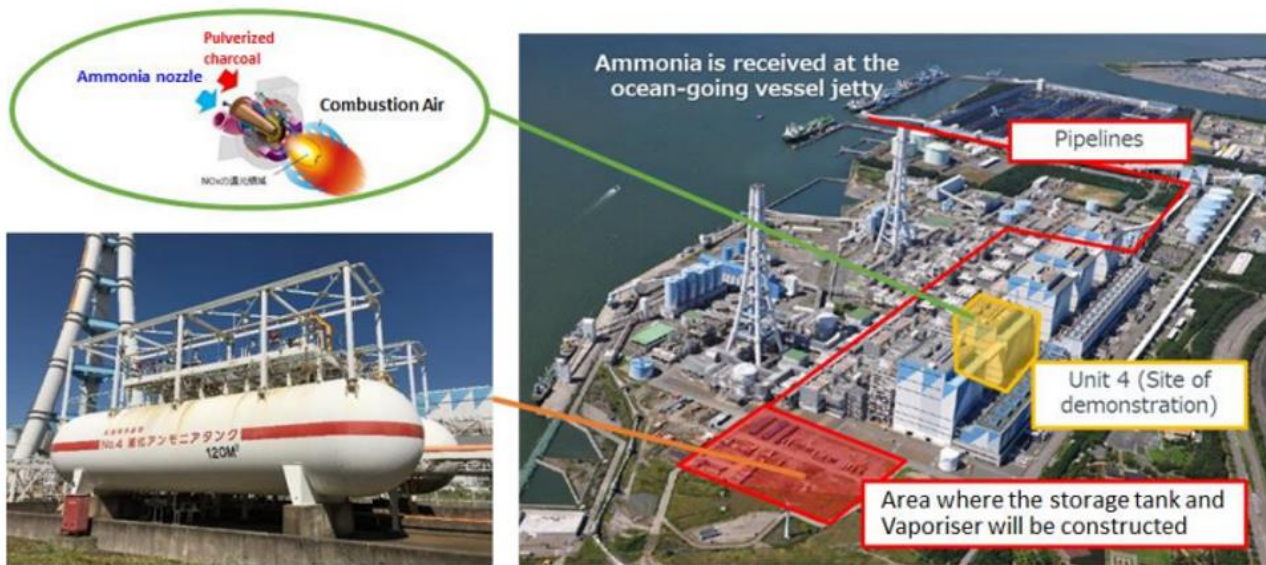

Source: JERA (2022).

Key points

- JERA and IHI⁴ have been conducting a demonstration project to establish technology for the large-volume co-firing of fuel ammonia at the Hekinan coal-fired power plant since the fiscal year of 2021 under the NEDO⁵ grant program.
- A 20% ammonia cofiring test has been started since fiscal year 2023 at an existing 1 GW USC coal-fired unit. According to JERA, the demonstration test of over 50% ammonia cofiring will be conducted by the fiscal year of 2028 at Hekinan and other coal-fired power plants in Japan.
- For the existing coal-fired power plants, modification is required in the boiler, ammonia tank and vaporiser to adapt to ammonia cofiring operation. The biggest challenge of using ammonia cofiring is controlling NOx emissions. Therefore, JERA will use modified burners that inject ammonia at the centre of a stream of pulverized coal and air.
- If 20% cofiring is done in this plant, 600 000 tonnes of ammonia will be required annually. Therefore, cofiring demonstration and establishing a fuel ammonia supply chain are simultaneously being studied.
- Under its "JERA Zero CO₂ Emissions 2050" objective, JERA has been working to reduce CO₂ emissions from its domestic and overseas businesses to zero by 2050, promoting the adoption of greener fuels and pursuing thermal power that does not emit CO₂ during power generation. JERA continues to contribute to the decarbonisation of the energy industry through its proactive efforts to develop decarbonisation technology while ensuring economic rationality.

⁴ IHI stands for IHI Corporation, a Japanese engineering corporation headquartered in Tokyo.

⁵ NEDO stands for the New Energy and Industrial Technology Development Organization, a national research and development agency that creates innovation by promoting technological development necessary for realization of a sustainable society.

Thermal efficiency improvement

Table 1.3. Thermal efficiency in different coal power technology

Technology	Efficiency rate	Coal consumption (g/kWh)	Steam temperature (°C)	CO ₂ intensity (gCO ₂ /kWh)
Integrated Coal Gasification Combined Cycle (IGCC)	46 to 50%	256-272	1300	629-680 ⁶
Advanced Ultra-supercritical	45 to 50%	230-320	≥700	670-740
Ultra-supercritical (USC)	Up to 45%	320-340	≥600	740-800
Supercritical	Up to 42%	340-380	550-600	800-880
Subcritical	Up to 38%	≥380	≤550	≥880

Source: compiled by the authors based on NextBig Future, Joban Power, and MHI.

Key points

- Coal-fired power plants generate steam within boilers to spin a turbine. Refinement of the technology has led to ever higher efficiency, with power plants categorised as subcritical, supercritical, ultra-supercritical, and advanced ultra-supercritical. The thermal efficiency rates are up to 38% for subcritical, 42% for supercritical, 45% for ultra-supercritical technology and 50% for the newly commercialised advanced ultra-supercritical.
- With increasing numbers of the most efficient coal-fired power plants, the average global thermal efficiency for coal-fired power plants has increased to 40%, up from 32% in 2002 (IEA, 2020b). Higher levels of thermal efficiency contribute to lower greenhouse gas emissions for the same amount of electricity generated. Greater thermal efficiency combined with advanced emission control equipment also leads to lower levels of pollutants such as NO_x, SO₂, and particulate matter.
- A 1.35-GW ultra-supercritical coal-fired unit at Pingshan Phase II (the extension of the Pingshan Power Plant), located in the Huaibei Economic Development Zone of Anhui Province (China), achieved a remarkable net efficiency of 49.3% - making it the most efficient coal-fired power plant in the world. The plant commenced operations in April 2022 (Power, 2023).
- The IGCC technology began commercial operations on 16 April 2021 at the Nakoso IGCC power plant in Fukushima prefecture, Japan (Power, 2021). The power station generates electricity with superior efficiency while simultaneously achieving greenhouse gas reductions.
- The Integrated Coal Gasification Fuel Cell Combined Cycle (IGFC) technology has the potential to enhance thermal efficiency to 55% by 2025, and it is expected to be commercialised during the 2030s (METI Journal).

⁶ CO₂ intensity of the Integrated Coal Gasification Combined Cycle technology is estimated to be a 10-15% lower than that of ultra-supercritical technology.

Figure 1.6: Osaki CoolGen demonstration project, Japan

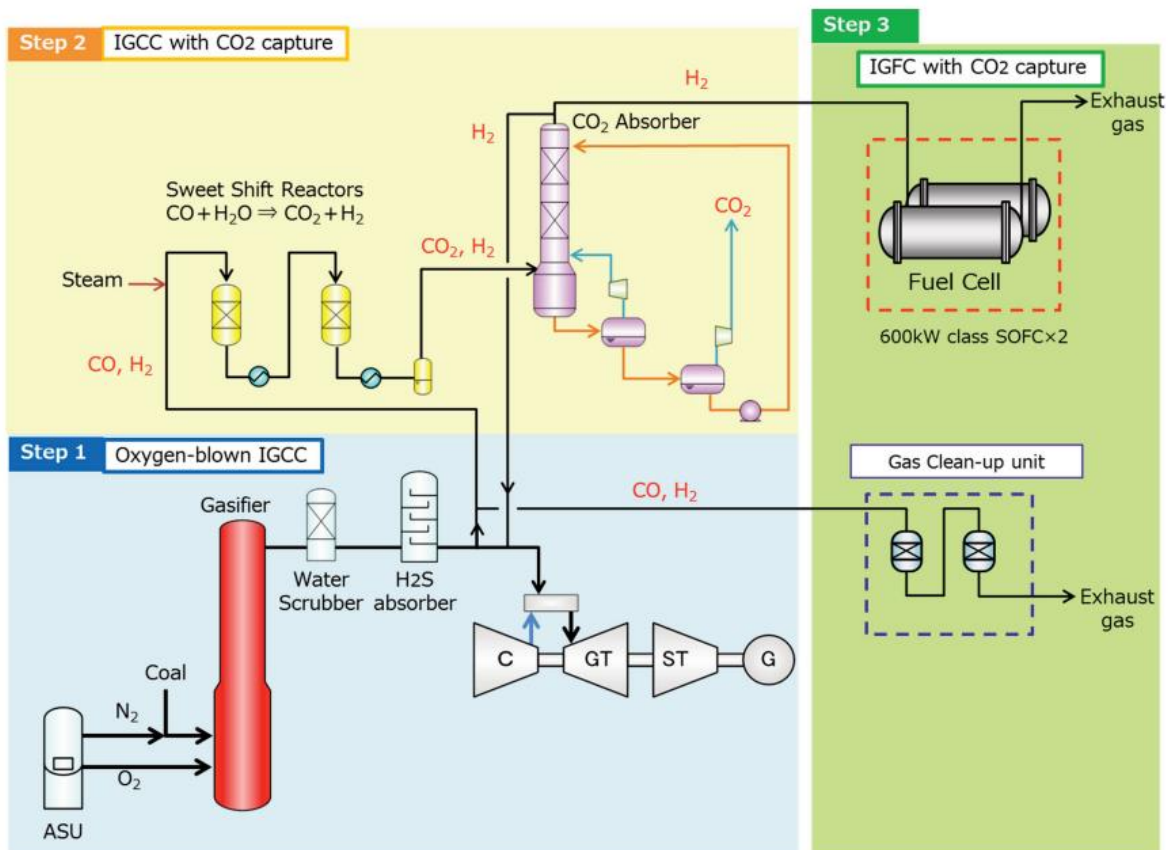

Source: Osaki CoolGen Corporation

Key points

- The Osaki CoolGen demonstration project officially started in 2012 to realise an innovative low-carbon emission coal-fired power plant, consisting of three steps.
- In the first step, project partners started constructing a 166-MW oxygen-blown IGCC demonstration plant in March 2013 and completed it in March 2017. The project has achieved the target of obtaining sufficient performance of an oxygen-blown IGCC (Power, 2022).
- In the second step, which was implemented between 2016 and 2020, the Osaki CoolGen project added the demonstration of oxygen-blown IGCC with CO₂ capture.
- The third step has been starting since April 2019. The Osaki CoolGen project completed the integration of a 1.2-MW solid oxide fuel cell (SOFC) and was tested in April 2022. It plans to capture a portion of its CO₂ emissions to produce food-grade purity CO₂ of about five tons per day, which is then transported by truck to a commercial tomato greenhouse near Hibikinada Greenfarm.
- The project has prompted NEDO to establish a carbon "recycling" research and development centre in Hiroshima prefecture. The centre explores, among other areas, the development of environmentally friendly concrete, selective synthesis technology for chemical products, a gas-to-lipids bioprocess, and bio-jet fuel made from microalgae.
- The Osaki CoolGen project's target is energy efficiency of 47%, with 90% capturing CO₂, in the case of a 500 MW commercial plant.

Coal gasification

Figure 1.7: Coal gasification with CCUS

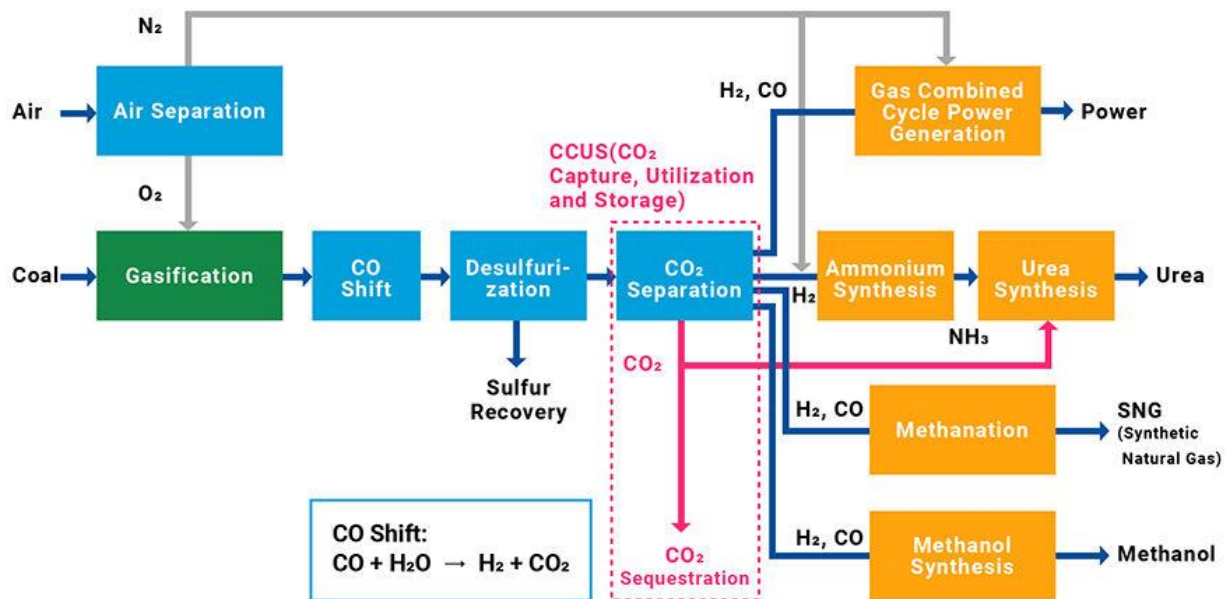

Source: Chiyoda corporation

Key points

- Coal gasification is another option to transform coal into synthetic gases which can be used in various sectors. Coal gasification is suitable for environment-conscious electric power generation and the production of chemical raw materials from cheap, low-grade coal.
- In coal gasification, coal is heated at high temperatures to produce hydrogen-rich syngas, which also contains CO and CO₂. The syngas can then be upgraded by converting the CO to CO₂ and more hydrogen using the water-gas shift reaction and then separating the hydrogen. This step allows CO₂ to be separated and sequestered, meaning coal gasification can be a low-carbon hydrogen production technology (ICSC, 2022).
- Hydrogen production from coal using gasification is a well-established technology that has been used for many decades by the chemical and fertiliser industries. Globally, around 130 coal gasification plants are in operation, more than 80% of which are in China (IEA, 2019b). In terms of gasification with carbon capture, three facilities currently produce hydrogen from coal, coke or asphaltene with a combined capacity of around 0.6 MtH₂ per year (Global CCS Institute, 2020).
- Coal gasification associated with CCUS will be a near-zero CO₂ emissions technology, expected to be the lowest cost source for large-scale hydrogen production in the near and medium term. The cost of hydrogen from coal gasification with CCUS is around 1.6 USD/kgH₂, which is relatively competitive to natural gas-based hydrogen (1.5 USD/kgH₂ to 2.3 USD/kgH₂) (ICSC, 2022). It is beneficial for coal-abundant economies in the APEC region, such as China, Australia and Indonesia.

Figure 1.8: The hydrogen energy supply chain project between Australia and Japan

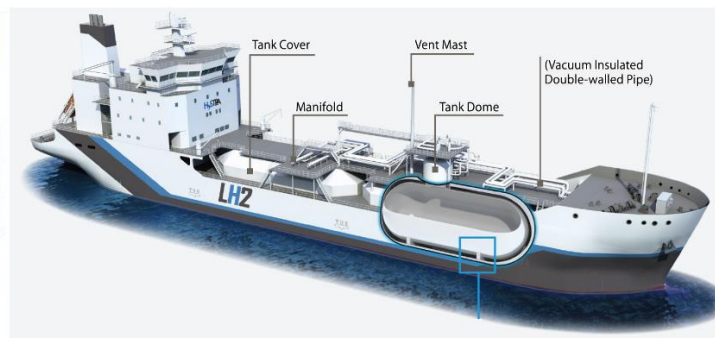
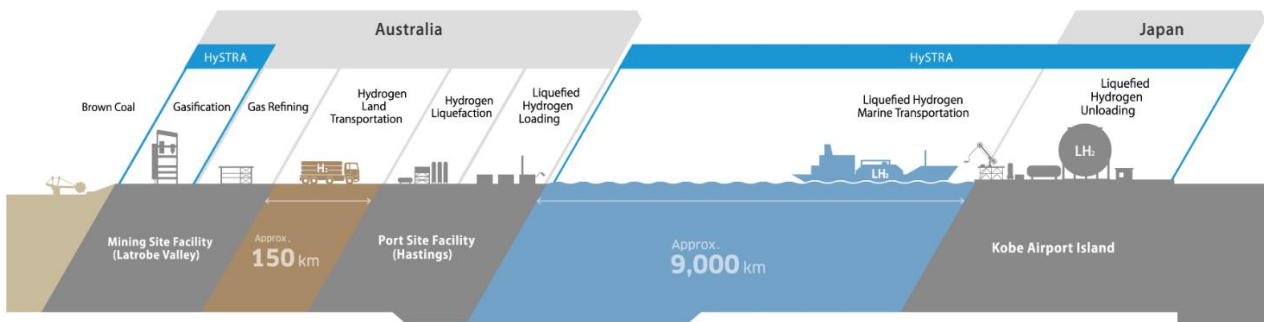

Source: HySTRA

Key points

- The Hydrogen Energy Supply Chain (HESC) project started in April 2018 with support from the Japanese and Australian governments. The HESC project includes production, transportation and storage, with the goal of delivering liquefied hydrogen to Japan on a scale that meets the local demand. The project includes the following two phases.
 - The pilot phase – demonstrating at pilot scale a fully integrated hydrogen supply chain between Australia and Japan over a one-year period.
 - The commercial demonstration phase – targeted for the 2030s with a potential of 225 000 tonnes of liquid hydrogen production per annum, depending on the outcomes of the pilot phase, regulatory approvals, community feedback, hydrogen demand trends and successful development of CCS technology.
- Key elements of the HESC pilot project include:
 - Coal gasification and gas-refining facilities adjacent to the AGL-owned Loy Yang A power station in the Latrobe Valley region of Victoria, Australia. The facility will use 150 tonnes of coal from the Loy Yang mine to produce 1-3 tonnes of hydrogen during the pilot phase.
 - The hydrogen gas will be transported in a high-pressure road tube trailer to pilot hydrogen liquefaction and loading facilities under construction at *BlueScope's* existing industrial site at nearby Western Port (Port of Hastings). The existing berth at the *BlueScope* site is suitable to allow the safe loading of liquefied hydrogen. No new dredging or other waterworks are required. The liquefaction facility will liquefy the hydrogen gas by cooling it to -253°C and reducing it to 1/800th of its gaseous volume.

- The hydrogen will be liquefied at the Port of Hastings, loaded and shipped to Kobe by a specially developed hydrogen marine carrier built by Kawasaki Heavy Industries, for which the naming ('Suiso Frontier') and launch ceremony was held in December 2019. The Suiso Frontier is the world's first marine carrier to transport liquid hydrogen. It is approximately 116 metres long and 19 metres wide and will use a cryogenic storage tank with vacuum insulation to contain the liquid hydrogen. Installation of the storage tank occurred in March 2020, and the carrier underwent operational testing successfully in the coastal waters of Japan in October 2020, with the first voyage from Japan to Australia towards the end of 2021.
- The liquefied hydrogen will be unloaded and stored at Kobe in Japan.
- In January 2022, the Suiso Frontier left Hastings (Victoria, Australia) with its cargo of liquid hydrogen, which was unloaded at the receiving terminal in the port of Kobe (Japan) in February 2022. This marked the completion of the pilot phase (CSIRO, 2022).
- Following the completion of the pilot phase, in early March 2023, Japan Suiso Energy announced it had chosen to allocate its Japanese Government's Green Innovation Fund grant of 220 billion Japanese Yen (approximately AU\$2.35 billion) to the commercial demonstration phase of the HESC Project in Victoria (CSIRO, 2023).
- The commercial demonstration phase would be delivered through two consortia: a production joint venture and a liquefaction and export joint venture:
 - A J-Power and Sumitomo Corporation joint venture (JPSC JV) would be responsible for the production and supply of gaseous clean hydrogen. The joint venture would initially produce between 30 000 and 40 000 tonnes per annum of gaseous clean hydrogen, which would be produced from Latrobe Valley coal with CCUS in the Bass Strait offshore Victoria. The JPSC JV notes that two carbon storage options in the Gippsland area are under consideration: the CarbonNet Project and the ExxonMobil affiliate-operated Gippsland Basin Joint Venture of South East Australian Carbon Capture Storage Hub.
 - A Kawasaki Heavy Industries, Iwatani Corporation and INPEX Corporation joint venture (Japan Suiso Energy-JSE) would be responsible for the liquefaction of the supplied gaseous clean hydrogen at the Port of Hastings and its shipment to Japan.
- A consortium of Japan's top energy and infrastructure companies, with the full support of the Victorian Commonwealth and the Japanese government, is working together to establish a commercial-scale hydrogen energy supply chain. This HESC project will put Australia and Japan at the forefront of hydrogen technology.

Carbon Capture, Utilisation and Storage

Figure 1.9: Coal-related CCS capacities in the APEC region

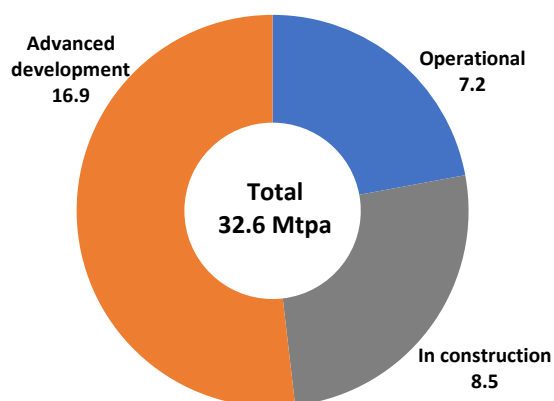

No	Project name	Location
1	Boundary Dam Carbon Capture and Storage	Canada
2	Sinopec Qilu-Shengli	China
3	Yangchang Yulin CO ₂ -EOR	China
4	China National Energy Taizhou	China
5	China National Energy Ningxia	China
6	Huaneng Longdong Energy Base	China
7	Yulin intergrated coal-to-liquid	China
8	Sinopec Shengli Power Plant	China
9	Petra Nova Carbon Capture	US
10	Great Plains Synfuels Plant and Weyburn-Midale	US
11	Minkota Power Project Tundra	US
12	Gerald Gentleman Station	US
13	Prairie State Generating Station	US

Source: compiled by the authors based on Global CCS Institute (2023).

Key points

- The COP28 ended with a historic deal that committed the world to a transition away from all fossil fuels for the first time. Alongside the move away from fossil fuels, the COP28 decision also calls for the acceleration of zero and low-emission technologies, including abatement and removal technologies such as CCUS. With such clear decisions, CCUS has clearly been recognised as a vital tool in the climate change toolkit.
- Globally, there are currently 13 coal-related CCUS projects in different development stages in the APEC region, with a total capacity of 32.6 Mtpa. Of these, six projects are operational with a capacity of 7.2 Mtpa (one in Canada, two in the United States and three in China).
- There are currently three coal-related CCUS projects under construction with a total capacity of 8.5 Mtpa, coming online in the coming years. All the above projects are located in China. Additionally, there are four coal-related CCUS projects in advanced development with a total capacity of 16.9 Mtpa (one in China and three in the United States).
- Among six coal-related CCUS operational facilities, three are associated with coal-fired power plants, and the other three projects include coal-to-syngas, coal-to-hydrogen, and coal-to-chemical plants.
- In the coal power sector, the Boundary Dam and the Petra Nova are the only two coal-fired power plants in the world with retrofitted CCUS facilities with a total capacity of 2.4 Mtpa.
- The Boundary Dam CCUS facility in Saskatchewan (Canada) is currently operational. Captured CO₂ from this facility is used for EOR, which involves injecting CO₂ into oil reservoirs to recover incremental oil from producing wells.
- The Petra Nova is another coal-fired CCUS facility used for EOR in Texas, United States, that was suspended in May 2020 due to operational problems and unfavourable economics. However, this facility was restarted in September 2023.

Figure 1.10: CCUS-equipped coal-fired power plant - The Boundary Dam, Canada

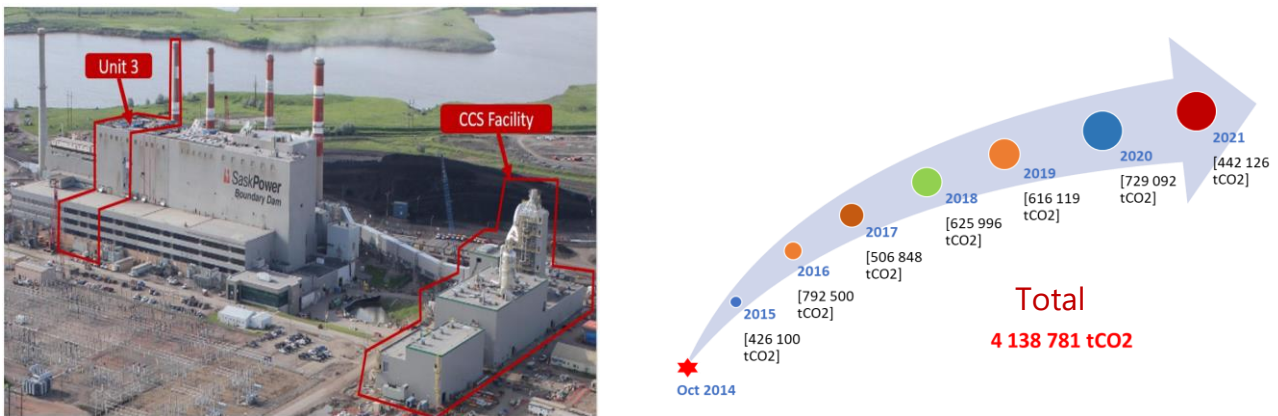

Source: compiled by the authors based on SaskPower, International CCS Knowledge Centre.

Key points

- The Boundary Dam is an 824 MW coal-fired power plant located in Saskatchewan, Canada. Generation Unit 3, which opened in 2014, is the world’s first commercial-scale CCUS at a coal-fired power plant.
- Unit 3 was originally scheduled for closure in 2013 after 45 years of service. A retrofit was undertaken to transform the unit into a reliable long-term producer of 110MW of clean baseload electricity and simultaneously supply CO₂ to an EOR project in the province. Unit 3 is expected to have an increased life expectancy of 30 years and has the potential to capture one million tonnes of CO₂ a year (Sask Power).
- The Unit 3 retrofit included the replacement of the existing steam turbine generator with a new one that could be integrated with the CO₂ and SO₂ capture mechanism. The captured CO₂ is compressed and transported through a 66 km-long pipeline to an EOR project near Weyburn, which is part of an agreement signed with Cenovus Energy to purchase the full volume of one million tonnes of CO₂ a year.
- Unused CO₂ is transported to an injection well and storage site belonging to an Aquistore research project that is managed by the Petroleum Technology Research Centre. The SO₂ provides feedstock to a 50-tonne per-day sulphuric acid plant, which will be built next to Unit 3. A flue gas desulphurisation (FGD) system was put in place to allow the installation of carbon capture equipment, which reduces CO₂ emissions by approximately 90%.
- From 2015 to 2021, over 4.0 million tonnes of CO₂ has been captured from the Boundary Dam Unit 3 since it began operating.
- Emerging economies will continue to consume more energy. Therefore, governments need to maintain the value of existing generation assets from diverse fuel sources, especially low-cost fuels such as coal. The Boundary Dam unit 3 project paves the way for continuing to rely on coal while simultaneously striving to lower greenhouse gas (GHG) emissions. Coal with CCUS can help coal become a sustainable, reliable, and clean energy source.
- CCUS is applicable beyond the power sector and can be applied to hard-to-abate sectors such as iron and steel and cement.

Chapter 2: Coal consumption

World and APEC coal consumption

Figure 2.1: Coal consumption growth rate for the world and selected APEC economies

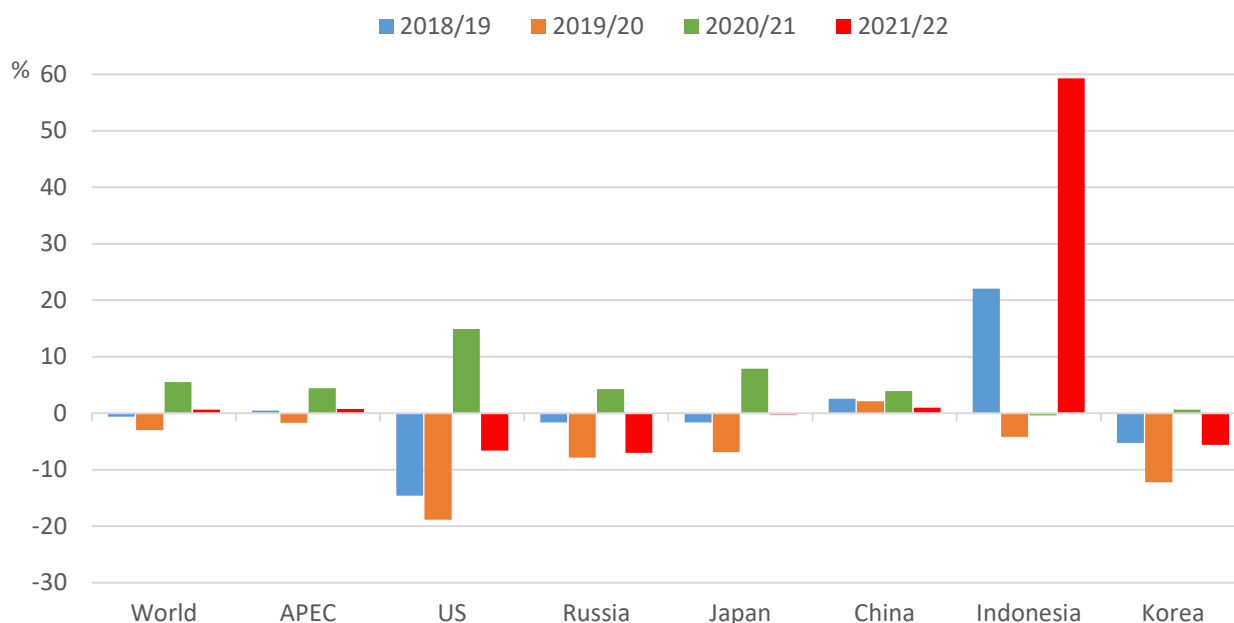

Source: compiled by the authors based on Energy Institute (2023).

Key points

- Global coal consumption slightly grew in 2022 by 0.65% compared to the previous year due primarily to recent surges in global natural gas prices. The total global coal consumption was almost the same as the peak year (2013), reaching 161.5 EJ in 2022.
- APEC coal consumption also showed a minor change, a 0.77% increase in 2022 relative to the 2021 level. The change in the APEC is often driven by the five largest coal consumption economies (China, United States, Japan, Russia, and Indonesia), which account for almost 90% of APEC coal consumption.
- The United States' coal consumption dropped 6.6% compared to the previous year, returning to the declining trend in coal consumption observed during the last two decades.
- Coal consumption in China, the world's largest coal consumer by far, grew by approximately 1% in 2022. It was the lowest growth in coal consumption since 2018.
- In 2022, coal consumption in Indonesia rose sharply (+59%) due to high coal demand to boost economic recovery following the COVID-19 pandemic, including the new coal-fired power plants that recently came online as well as the expansion of the nickel industry (Mongabay, 2023).
- Coal consumption in Russia, Korea, and Japan in 2022 declined by 7%, 5.6%, and 0.2%, respectively, relative to the previous year.

Figure 2.2: APEC coal consumption by region

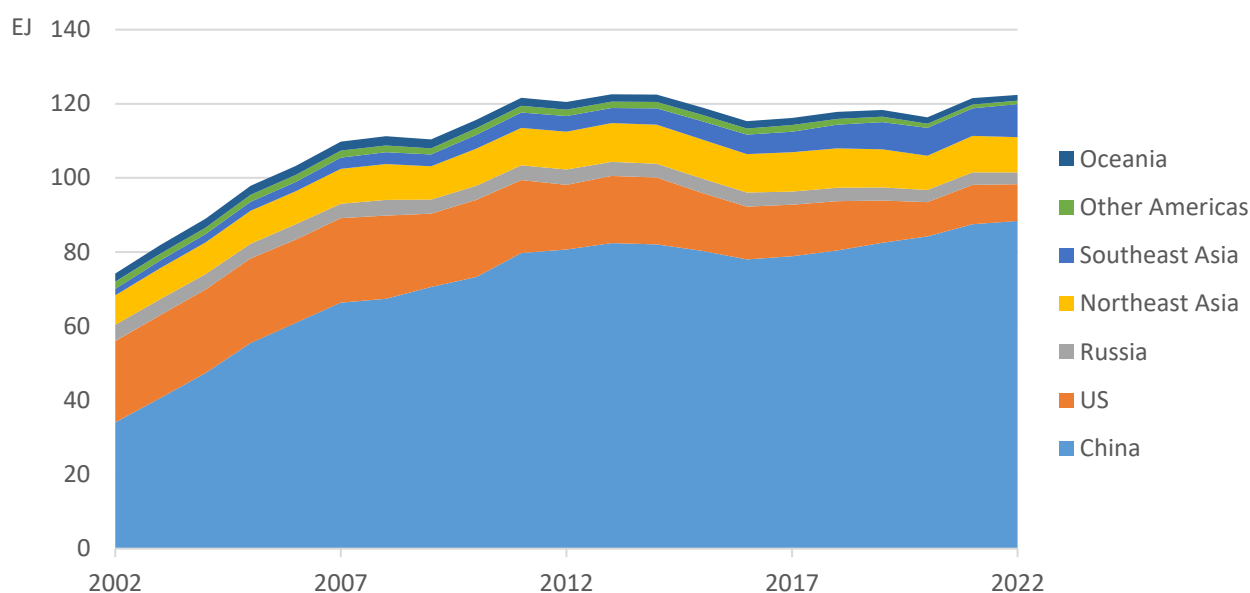

Source: compiled by the authors based on Energy Institute (2023).

Key points

- APEC-wide coal consumption rose 1.65-fold over two decades, reaching over 122 EJ in 2022, close to its previous peak in 2013.
- China, the largest coal consumer in the APEC and the world, substantially increased its coal consumption over the 2002-2010 period, then continued to increase at a slower rate over the last 12 years despite a slight drop in 2015-2018. China's coal consumption reached an all-time record high in 2022, accounting for approximately 72% of the total coal consumption in the APEC region.
- Coal consumption in the United States has declined gradually since 2007. In 2022, the United States consumed around 8% of the total APEC-wide coal consumption.
- Northeast Asia, including Japan, Korea, Chinese Taipei, and Hong Kong, accounted for 7.8% of the total APEC coal consumption in 2022, mainly consumed by Japan and Korea.
- The Southeast Asia economies accounted for 7.3% of APEC coal consumption in 2022. Indonesia consumed the most, followed by Viet Nam.
- Oceania, including Australia and New Zealand, accounted for 1.3% of the APEC-wide coal consumption in 2022. Australia consumes over 95% of coal consumption in the Oceania region. A slight decline trend in coal consumption has been seen in this subregion, falling by 27% over 2002-2022.
- Other Americas, namely, Canada, Chile, Mexico and Peru, consumed less than 1% of APEC coal consumption.
- Russia consumed 2.6% of total APEC coal consumption in 2022, which has gradually declined over the last two decades.

Figure 2.3: Coal consumption in China, US, and Russia, 2012-2022



Source: compiled by the authors based on Energy Institute (2023).

Key points

- China's coal consumption rose 9.5% over the last decade, from 80.7 EJ in 2012 to 88.4 EJ in 2022. Approximately 64% of coal was used for power generation, and around 24% was used for energy-intensive industries such as steelmaking, aluminium smelting, cement manufacturing and fertiliser production. The power sector in China is still highly dependent on coal. In recent years, coal-fired power generation accounts for approximately two-thirds of total electricity generation in China.
- In contrast, the United States' coal consumption fell by 43.3% over the 2012-2022 period, from 17.4 EJ in 2012 to approximately 9.9 EJ in 2022. Coal consumption has substantially fallen since 2007 due to competitive prices of shale gas relative to coal and the widespread deployment of renewable energy despite a temporary surge in coal consumption in 2021. Coal consumption in the United States is expected to continue declining due to coal-to-gas switching in the power sector and lower investment in coal mines.
- Russia's coal consumption fell by 22.6% over the 2012-2022 period to reduce carbon emissions as Russia ratified the Paris Climate Agreement in 2019. Even though coal phase-out is not a priority for Russia, the global low-carbon trend is affecting the Russian coal sector. Additionally, coal consumption has gradually declined for a decade due to the competition with natural gas (Korppoo, A. et al., 2021).

Figure 2.4: Coal consumption in Northeast Asia, 2012-2022

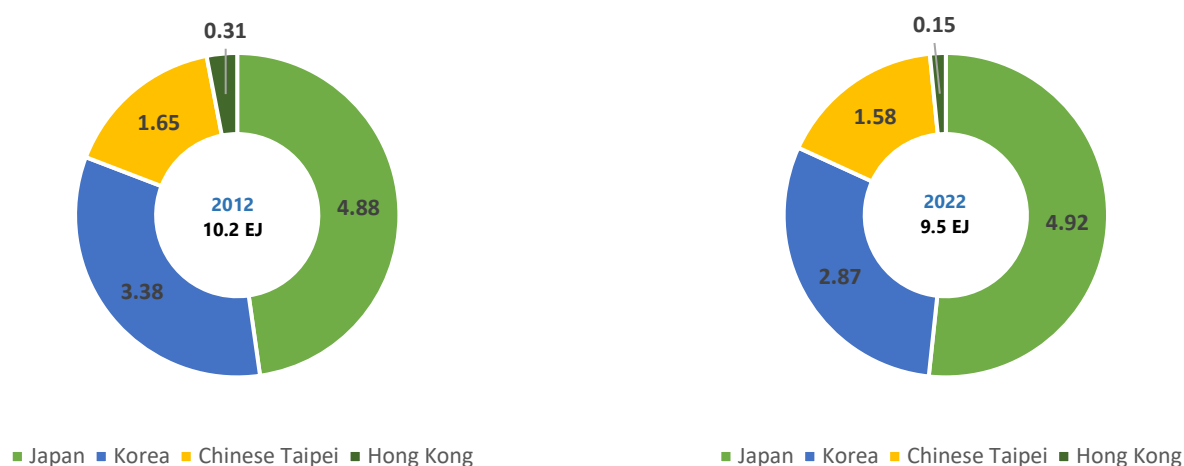

Source: compiled by the authors based on Energy Institute (2023).

Key points

- Coal consumption in the Northeast Asia economies declined from 10.2 EJ to 9.5 EJ over a decade. The fall in coal consumption has recently been seen due to the environment-related issues and net-zero commitments of economies in this region.
- Japan was the largest coal consumer in Northeast Asia, with 4.92 EJ in 2022. Although Japan plans to reduce reliance on coal power generation, with plans to phase out inefficient coal power plants by 2030, Japan did not sign the Global Coal to Clean Power Transition Statement at COP26 to phase out all coal-fired power plants by the 2030s or 2040s. Coal power technologies are still a significant business for major Japanese power plant makers and power utilities. As a long-time supporter of this industry, the Government has not yet moved away from coal (Japan Beyond Coal). However, Japan committed to phasing out coal-fired power and entirely or predominantly decarbonise the power sector by 2035 at the 2022 G7 summit (Kiko Network, G7 Germany).
- Korea's coal consumption declined by 15% from 3.38 EJ in 2012 to 2.87 EJ in 2022, contributing to carbon emissions reduction to reach carbon neutrality by 2050. Improved energy efficiency, increased share of renewable energy, and the emergence of a hydrogen industry are expected to offset the reduction in coal consumption.
- Chinese Taipei's coal consumption declined by 4.2% over the last decade due to the Government's efforts to reduce reliance on coal-fired generation. Power companies have experienced protests by local communities related to environmental issues such as PM2.5 in the Taichung area, which hosts one of the ten largest coal plants in the world⁷. In January 2021, the Parliament of Chinese Taipei adopted a resolution to accelerate the decommissioning of the power plant. The ten 550 MW coal-fired units are to be retired by 2035 instead of 2046 as initially planned by Taipower. The subcritical coal units will be preserved as a national security emergency reserve. Four gas-fired power plants will be built on the site to replace the coal units, though a commissioning date for these new plants is unclear (Global Energy Monitor).

⁷ PM2.5 refers to particles that have diameter less than 2.5 micrometres (more than 100 times thinner than a human hair) and remain suspended for longer.

Figure 2.5: Coal consumption in Southeast Asia, 2012-2022

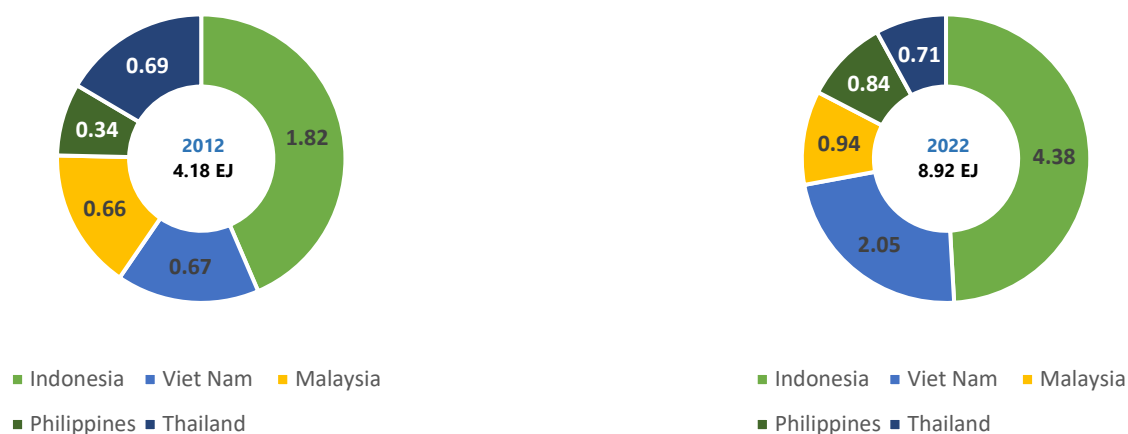

Source: compiled by the authors based on Energy Institute (2023).

Key points

- Due to high energy demand caused by rapid economic growth, coal consumption in Southeast Asia doubled from 2012 to 2022, from 4.18 EJ in 2012 to 8.92 EJ in 2022. Coal is mainly used in the power sector as most economies in Southeast Asia rely on coal-fired power generation.
- Indonesia was the largest coal consumer among Southeast Asia economies, with 4.38 EJ in 2022, a 2.4-fold increase relative to 2012. Coal is used mainly in the power sector, accounting for around 70% of the total coal consumption in recent years. Given its large coal resources, Indonesia is a major thermal coal producer and exporter worldwide.
- Viet Nam was the second-largest coal-consuming economy in the region in 2022. The coal consumption increased three-fold from 0.67 EJ to 2.05 EJ to meet the high coal demand for coal-fired power generation and industry over the 2012-2022 period. Approximately 70% of coal is consumed in coal-fired power plants, and the remainder is for heavy industries and other sectors. The electricity production from coal-fired power plants has increased approximately six times over the last decade. Although Viet Nam is a coal-producing economy, Viet Nam has started to import a large amount of coal since 2014 to supplement its domestic production.
- Coal consumption in Malaysia rose by 1.42 times over the last decade due to a high increase in coal-fired power capacity. Coal dominates the power sector, which makes up 92% of Malaysia’s coal consumption. However, coal also provides heat for industrial processes, particularly cement, iron, and steel.
- Coal consumption in the Philippines rose approximately 2.5 times over the 2012-2022 period, mainly used for power and industrial sectors. Although coal is the single biggest source of carbon emissions, coal continues to be supported by both the Government and businesses in the Philippines as it is the cheapest fuel option.
- Thailand’s coal consumption only rose by approximately 3% over the last decade, the lowest growth among the Southeast Asia economies. Unlike the above economies, Thailand uses just above 50% of total coal consumption for the power sector, while the remainder is used for industrial processes.

Figure 2.6: APEC coal consumption: history and outlook

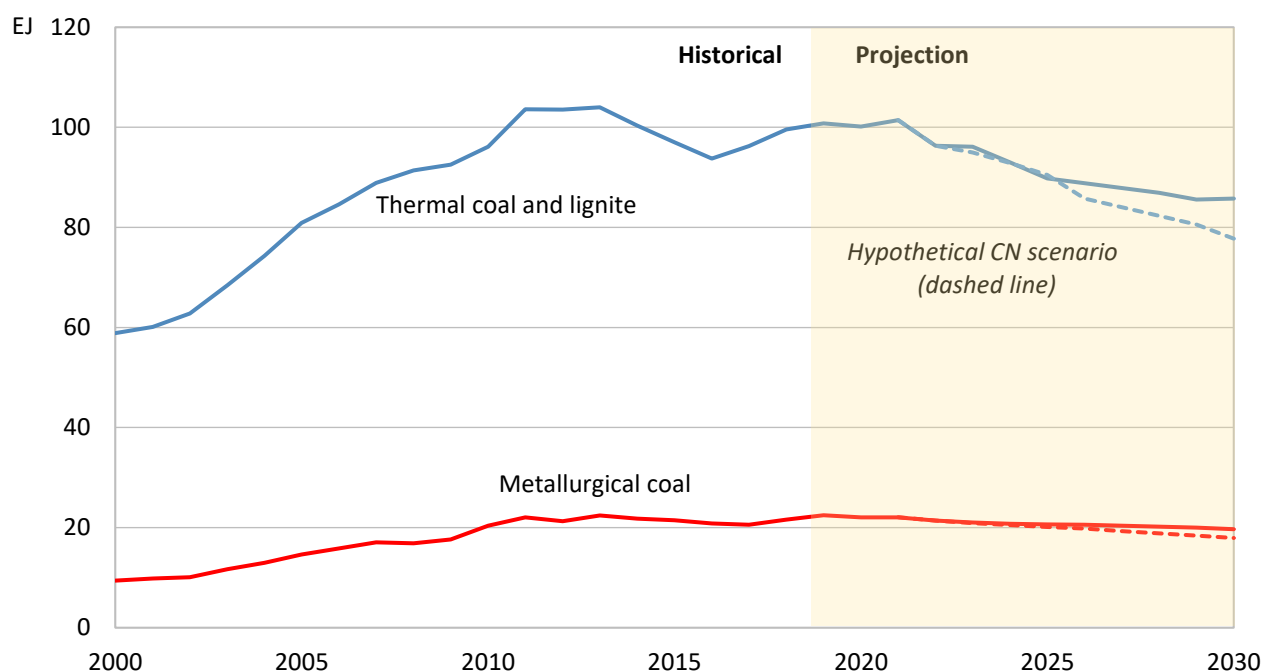

Source: compiled by the authors based on EGEDA (2021) and APEC Outlook 8th (2022).

Key points

- While there has been a rebound in APEC thermal coal consumption in the latter half of the 2010s, thermal coal consumption is projected to decline through the 2020s. The pace of decline will increase as many economies aim to achieve greater emissions reduction. In contrast, metallurgical coal demand will maintain a high plateau, with consumption only decreasing by a small amount in the hypothetical carbon neutrality (CN) scenario of the 8th APEC Energy Outlook.⁸
- Coal phase-down and phase-out policies have been consolidated based on the commitments of APEC leaders in late 2021. Nine APEC economies signed the Global Coal to Clean Power Transition Statement at COP26 in Glasgow, wherein they committed to not building any new coal-fired power plants from the 2030s or 2040s, depending on their economic situation.
- In the next decade, coal consumption is expected to decline mainly in the power sector, while metallurgical coal is still significant for heavy industrial sectors such as iron and steel manufacturing.

⁸ The medium and long-term projection data was modelled in August 2021. Therefore, it did not cover the recent change in coal consumption due to the Russian-Ukraine conflict.

Thermal coal

Figure 2.7: APEC thermal coal (including lignite) consumption by economy: history and outlook

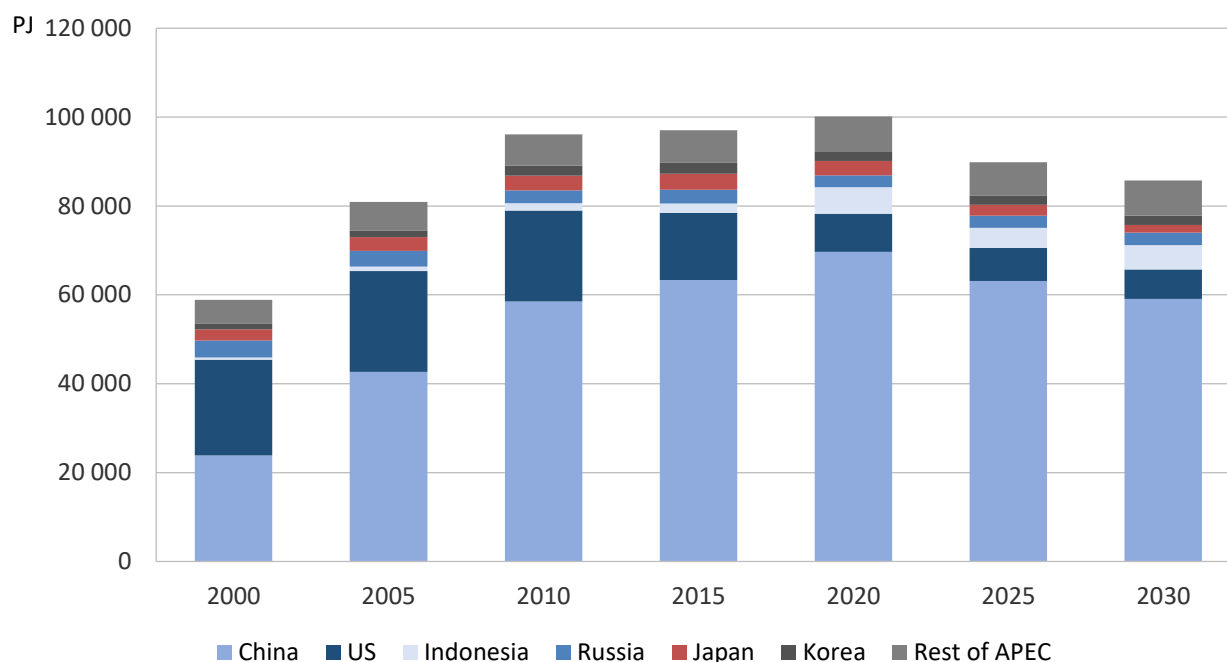

Source: compiled by the authors based on EGEDA (2021) and APEC Outlook 8th (2022).

Key points

- In the APEC region, China remains the largest consumer of thermal coal (including lignite). The thermal coal consumption share has increased from about 40% in 2000 to approximately 70% of APEC thermal coal consumption in 2019. The power sector drives this consumption, though coal-fired heating in the non-power sector has also accounted for a significant portion of this consumption. In recent years, natural gas has replaced coal-fired heating extensively, particularly in northern Chinese cities. This will contribute to lower levels of thermal coal demand growth moving forward.
- In contrast, the United States' thermal coal consumption share has declined from 36% of APEC thermal coal consumption in 2000 to 11% in 2019 (IEA, 2021). This represents a halving in absolute consumption for the period.
- APEC thermal coal consumption is projected to decline through the 2020s in the reference scenario that has been modelled for the APEC Energy Demand and Supply Outlook 8th Edition. While there is likely to be an absolute decline in thermal coal consumption, certain APEC economies in Southeast Asia have posted strong growth in recent years.
- While almost all APEC economies are expected to decline their coal consumption through 2030, thermal coal consumption is projected to rise in Indonesia and Viet Nam by 2030.

Figure 2.8: Coal share in the APEC generation mix

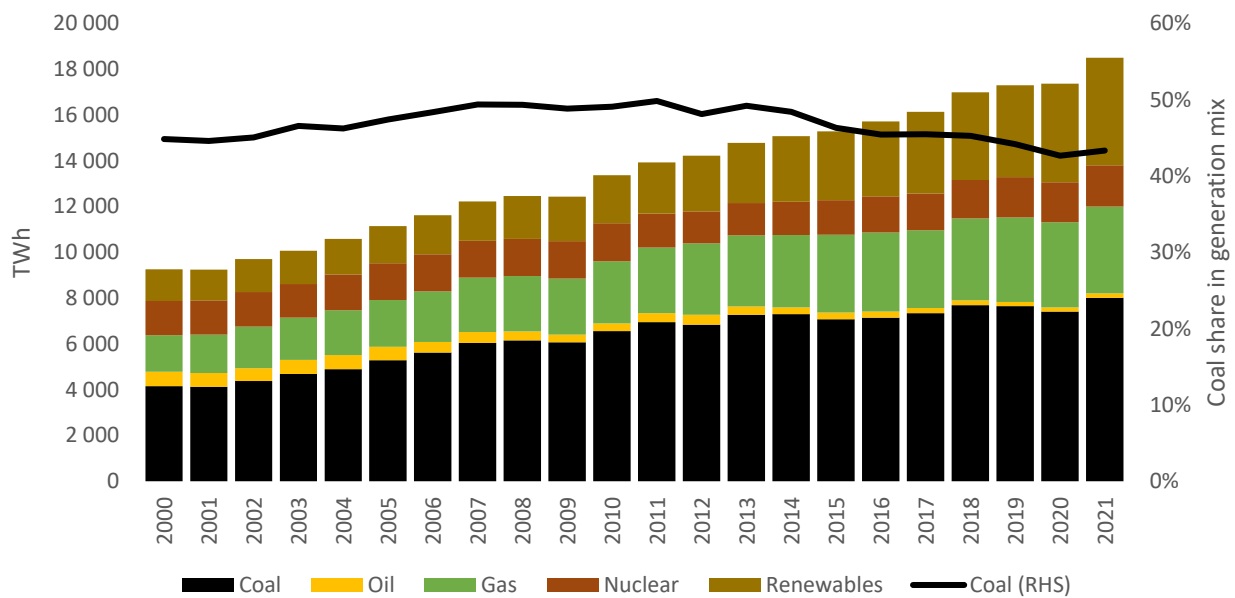

Source: compiled by the authors based on EGEDA (2022).

Key points

- Coal is still the largest contributor to the APEC-wide generation mix. However, coal share in the total generation has been gradually declining from 49% in 2013 to around 43% of total power generation in recent years.
- In 2021, the high gas prices and energy supply disruptions prompted several APEC economies to start increasing coal use in power generation. Electricity generation from coal increased by approximately 16% in the United States in 2021 compared to the 2020 level, followed by Russia (+16.4%), China (+8.5%), Indonesia (+5%) and Chinese Taipei (+3.4%) (BP, 2022).
- The declining trend of coal share in the generation mix mainly occurred in several APEC economies, such as the United States, Canada, and Australia, while Southeast Asia economies still rely on coal in their power sector. Phasing out coal will be extremely challenging, but a handful of economies are already proving that a rapid, sustained shift is possible. While each one must chart its own path forward, other coal-power-reliant economies can learn from these economies.
- There are two positive examples in the APEC economies. The United States reduced the share of electricity from coal generation by half, from 39% in 2014 to 19% of the total generation mix in 2022, replacing it with a combination of natural gas, solar and wind. In Chile, coal plants were booming as recently as a decade ago, but the economy has quickly reversed course; it is now supporting the early retirement of coal plants and replacing them mainly with solar and wind power (World Resources Institute, 2023).

Figure 2.9: Thermal coal (including lignite) consumption in selected Southeast Asia economies

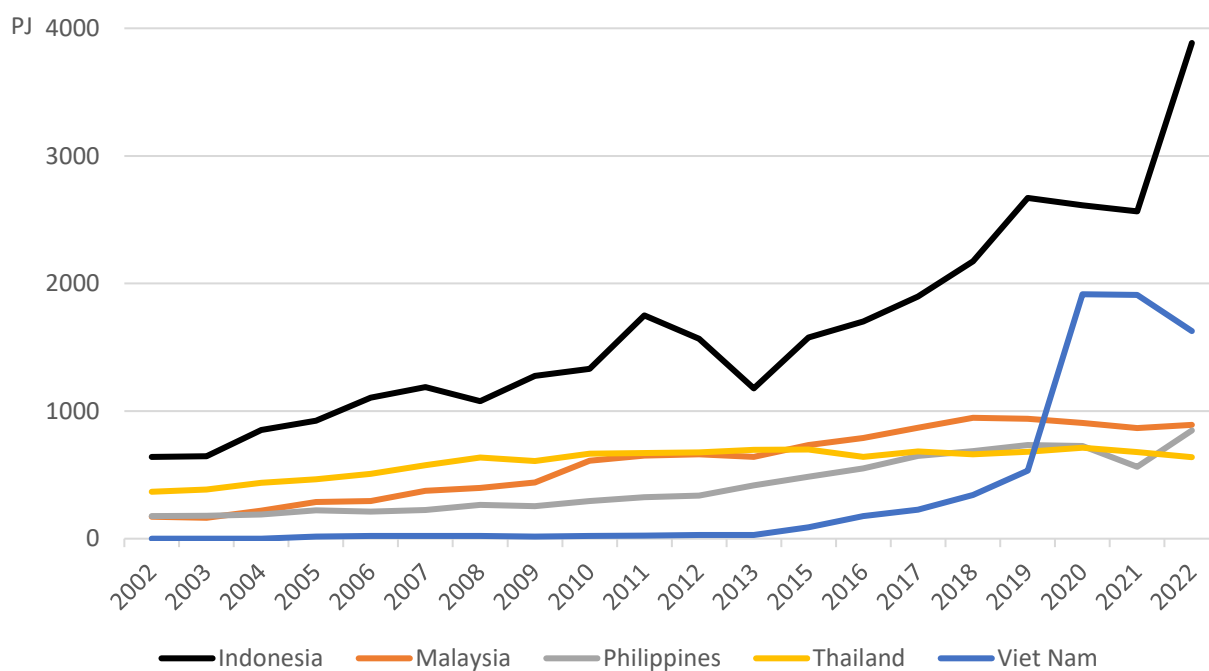

Source: compiled by the authors based on IEA (2023).

Key points

- Thermal coal (including lignite) consumption in the Southeast Asia economies has risen noticeably over the last decade, particularly in Indonesia and Viet Nam. Southeast Asia economies will likely continue to rely on coal for at least the next decade to meet their growing electricity demand.
- Indonesia's thermal coal consumption increased sharply in 2022 due to the many new coal-fired power plants that came online in recent years. As a result, around 43% of electricity was produced from coal in 2022. Additionally, Indonesia's industrial parks, particularly those on the islands of Sulawesi and Halmahera, which have become major hubs for nickel and aluminium processing, are also heavily reliant on coal. They consume 15% of the economy's coal power output (Mongabay, 2023).
- In Viet Nam, a newly approved Power Development Plan 8 (PDP8) limits the total coal power capacity to 30 GW by 2030 from the current installed capacity of 25.4 GW. However, the surging consumption of thermal coal is being driven by new coal-fired power plants that have been commissioned in recent years. The year 2022 was a special case. Due to the high price of imported coal in 2022, the capacity factor of coal-fired power plants in Viet Nam declined and was offset by increased utilization of hydropower. Consequently, coal thermal consumption for coal-fired power plants dropped considerably in 2022 relative to the 2021 level.
- Announcements by Japan, Korea, and China in 2021 to no longer provide state-based financing for overseas unabated coal projects are likely to slow the coal power deployment in developing economies. In June 2022, the Japanese government announced the halt of financial aid for constructing coal-fired plants in Indonesia (the Indramayu plant) and Bangladesh (the Matarbari plant) in response to international criticism of coal-fired power (Nikkei Asia).

Metallurgical coal

Figure 2.10: APEC metallurgical coal consumption by economy: history and outlook

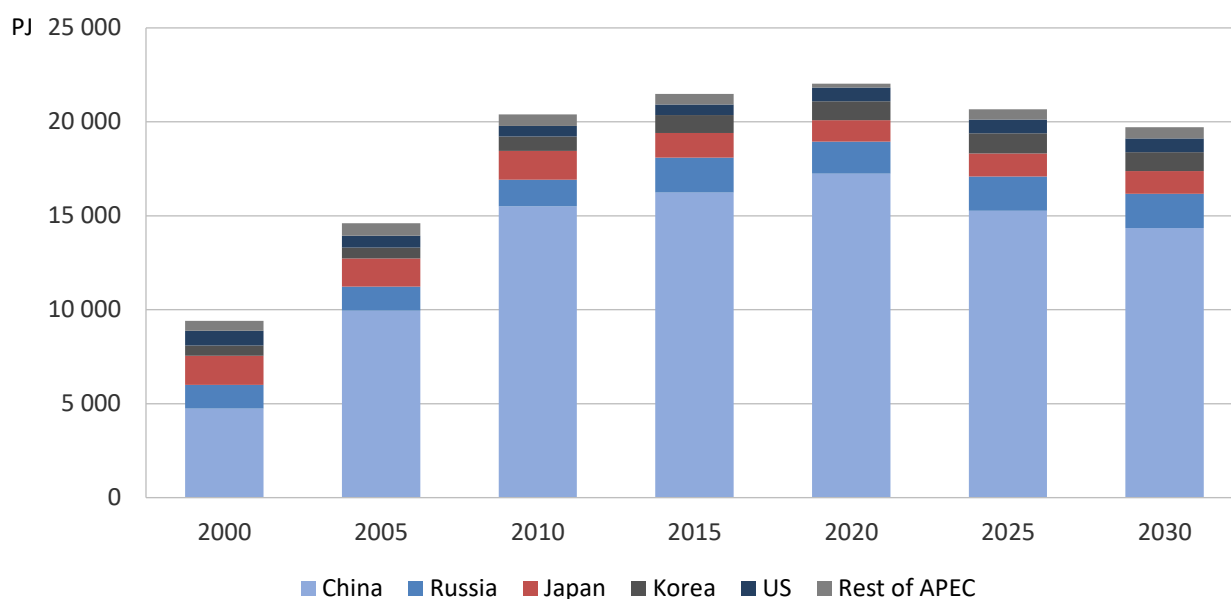

Source: compiled by the authors based on EGEDA (2021) and APEC Outlook 8th (2022).

Key points

- China remains the dominant consumer of metallurgical coal in APEC, owing to its global leadership in steel production. Even in the face of a global slowdown in steel production of 0.9% in 2020, China posted steel production growth of 5.2%. This large increase in production when the rest of the world was contracting meant that China accounted for 57% of global steel production in 2020, up from 53% the year before (WSA, 2021).
- China's metallurgical coal consumption increased from 15 500 PJ in 2010 to over 17 000 PJ in 2020, representing 78% of APEC metallurgical coal consumption. Russia was the next largest consumer of metallurgical coal in 2020, though the consumption is an order of magnitude less than China's, at 1709 PJ. Japan, Korea, and the U.S. are the next most prominent metallurgical coal consumers in APEC, consuming coal at levels closer to 1000 PJ in 2020.
- Higher levels of steel production only partly explain China's greater metallurgical coal consumption. Metallurgical coal consumption is also higher in China due to a larger proportion of steel production being reliant on oxygen furnaces relative to other APEC steel-producing economies. The proportion of oxygen-based steel production processes in China was 91% in 2020. In contrast, Russia (66%), Japan (75%), Korea (69%), and the United States (29%) relied less on oxygen-based processes, instead consuming higher levels of electricity via electric arc furnaces, which are reliant on scrap metal (WSA, 2021).
- It is expected that China will remain the largest metallurgical coal consumer, accounting for 73% of the APEC metallurgical coal consumption by 2030, followed by Russia and Japan.

Chapter 3: Coal production

World and APEC coal production

Figure 3.1: Coal production growth rate for the world and selected APEC economies

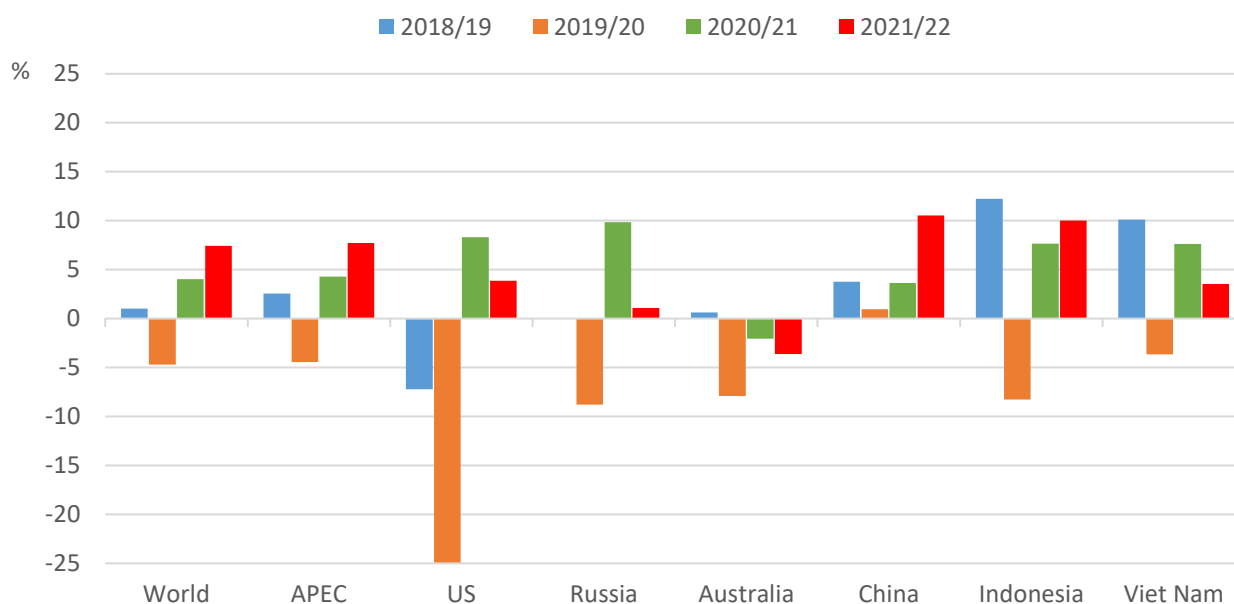

Source: compiled by the authors based on Energy Institute (2023).

Key points

- Global coal production rose 7.4% in 2022 to meet the high demand following the COVID-19 pandemic. Coal production in 2022 was even much higher than the record-high level in 2019 after a dramatic fall in coal production in 2020. In the APEC region, coal production rose 7.7% in 2022 compared to 2021, though the rising trend was not uniform across all economies.
- China, the world's largest coal producer, increased coal production by 10.5% in 2022 compared to the previous year in response to the high demand for coal, particularly for power generation. After the coal crisis in 2021, China increased its coal production at existing coal mines and reopened the closed coal mines in the Inner Mongolia and Shanxi areas to meet the rising domestic coal demand.
- Indonesia's coal production rose 10% in 2022, the second-highest growth among APEC economies after China. The increased coal production was both for export and domestic use.
- Coal production in Australia dropped by 3.6% in 2022 compared with 2021 due to lower metallurgical coal exports.
- The United States and Russia showed a smaller increase in coal production of 3.9% and 1.1% in 2022, respectively.

Figure 3.2: APEC coal production by region

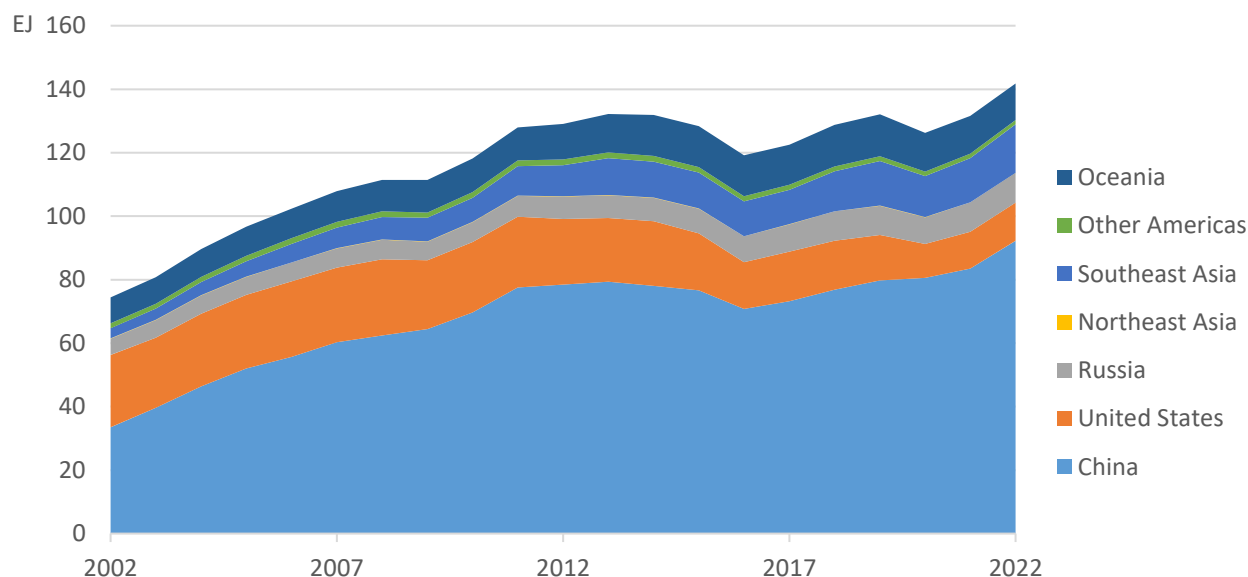

Source: compiled by the authors based on Energy Institute (2023).

Key points

- APEC coal production reached an all-time record high of approximately 142 EJ in 2022, a 7.7% increase relative to the previous year.
- China, the largest coal producer in the APEC and the world, produced 92.2 EJ, accounting for approximately 65% of APEC coal production in 2022. Many coal mines have been closed in the last five years due to mining safety and land-use rights for mining issues. In order to offset the coal production shortage from closed coal mines, the Chinese Government boosted the coal production from existing large mines.
- Southeast Asia produced 15.3 EJ in 2022, accounting for 10.7% of the total APEC coal production. Indonesia has dominated coal production in the region for decades, followed by Viet Nam and Thailand.
- Oceania produced 11.5 EJ, accounting for 8.1% of APEC coal production in 2022, while other Americas accounted for less than 1%.
- The United States and Russia were the third and fifth largest coal producers in 2022, accounting for 8.5% and 6.6% of APEC coal production, respectively.

Figure 3.3: Coal production in China, US, and Russia, 2012-2022

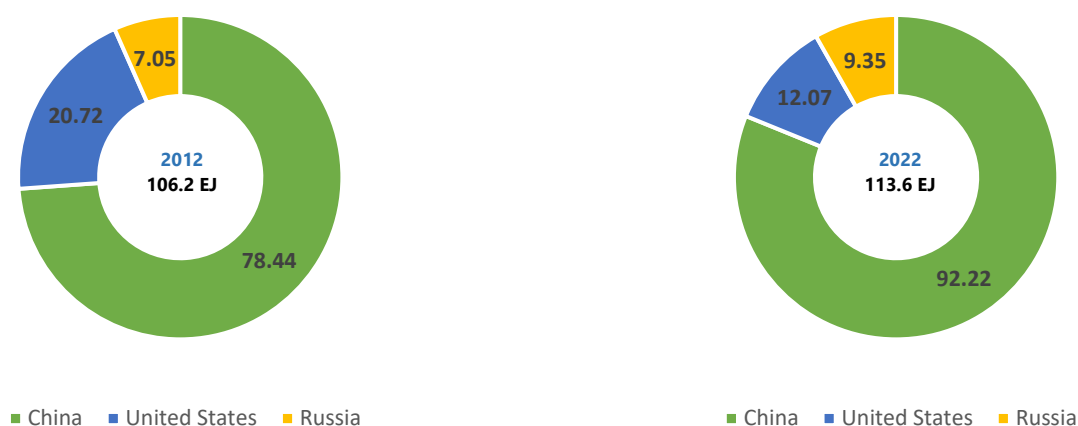

Source: compiled by the authors based on Energy Institute (2023).

Key points

- Coal production in China grew substantially over the last decade (2012-2022), with an increase of 17.6% over the last ten years. Although high domestic coal production was achieved in 2022, China is still the largest thermal and metallurgical coal importer.
- In 2022, China’s coal production reached a new record-high level of 92.2 EJ due to high coal demand for both coal-fired power and industrial plants. The coal crisis in the second half of 2021 caused electricity blackouts in four provinces (Liaoning, Hei Longjiang, Jilin and Guangdong), disrupting the daily lives of 10 million people. In response, the authorities asked coal enterprises to rapidly increase coal production at existing coal mines while reopening closed coal mines in the Inner Mongolia and Shanxi areas.
- Russia achieved substantial growth in coal production over the last decade (+32.6%), with production increasing from 7.0 EJ in 2012 to 9.3 EJ in 2022. As the third largest coal-exporting economy in APEC, over half of its coal production has been used for exports in recent years.
- In contrast, coal production in the United States fell by approximately 42% in the 2012-2022 period, responding to declining coal demand except in 2021 and 2022. U.S. coal production increased by 3.8% in 2022 to meet the strong domestic coal demand amid high gas prices and strong growth in electricity consumption.

Figure 3.4: Coal production in Southeast Asia, 2012-2022.



Source: compiled by the authors based on Energy Institute (2023).

Key points

- Southeast Asia showed the fastest growth among subregions in APEC, a rise from 9.8 EJ to 15.3 EJ over the 2012-2022 period.
- Indonesia, the largest coal producer and exporter in Southeast Asia, increased its coal production by almost 63%, from 8.5 EJ in 2012 to approximately 14 EJ in 2022. Although the growth in coal consumption for domestic use has been seen over the last decade, most of the coal production was used for export. In 2022, Indonesia exported 9.19 EJ, accounting for approximately 65% of the total coal production.
- In 2022, Indonesia's coal production grew by 10% after a pandemic-induced drop in coal demand in 2020 and 2021. Despite extreme weather in Kalimantan and Sumatra, coal production growth was the highest among APEC economies.
- Viet Nam increased its coal production slightly over the last decade, mainly mined in the northern provinces and Quang Ninh anthracite coal basin. However, the complex geological conditions and deep coal seams hinder the growth of coal production in these coal fields. The Red River Delta coal basin is a newly discovered sub-bituminous coal resource in Viet Nam, but it has not been mined due to technical and economic obstacles.
- Thailand's coal production fell by 30%, from 0.2 EJ in 2012 to 0.14 EJ in 2022.

Figure 3.5: Coal production in Oceania, 2012-2022



Source: compiled by the authors based on Energy Institute (2023).

Key points

- In the Oceania region, coal is primarily produced by Australia. Over the last decade, coal production rose slightly from 11.3 EJ in 2012 to 11.5 EJ in 2022. Only a small portion has been used domestically; the remainder was exporter.
- Australia exports most of its coal production, capitalising on its abundant coal resources and strong ongoing coal demand from Asia. Supplier reliability, proximity to key markets and good infrastructure availability put Australia in a strong position to take advantage of growing demand from customers in Japan, China, India, Taiwan, Korea and Europe, as well as newer buyers in Vietnam, Malaysia, the Philippines and Thailand. In 2022, Australia exported 8.39 EJ of coal, accounting for about three-quarters of Australia’s total coal production.
- The majority of Australia’s black coal basins are in New South Wales and Queensland, while the main brown coal basins are in Victoria. The coal industry employed around 46 000 people in 2022, and is projected to employ around 67 500 people by 2025.
- Open-cut coal mines are the most visible sign of coal mining in Australia – and make up most of the coal mine operations. In New South Wales, open cuts dominate the Hunter Valley coal mining. While there are environmental and community benefits of underground mining, the trend in Australia is currently moving in the other direction. In New South Wales open-cut mines now make up 80% of coal production, increasing from 75% just a few years ago. It’s a similar situation in Queensland, with the top 10 producing mines being open-cut. Data released by Global Energy Monitor indicates that Australia is out of step with the rest of the world, which is closer to a 50/50 balance between open-cut and underground mining.

Figure 3.6: APEC coal production: history and outlook

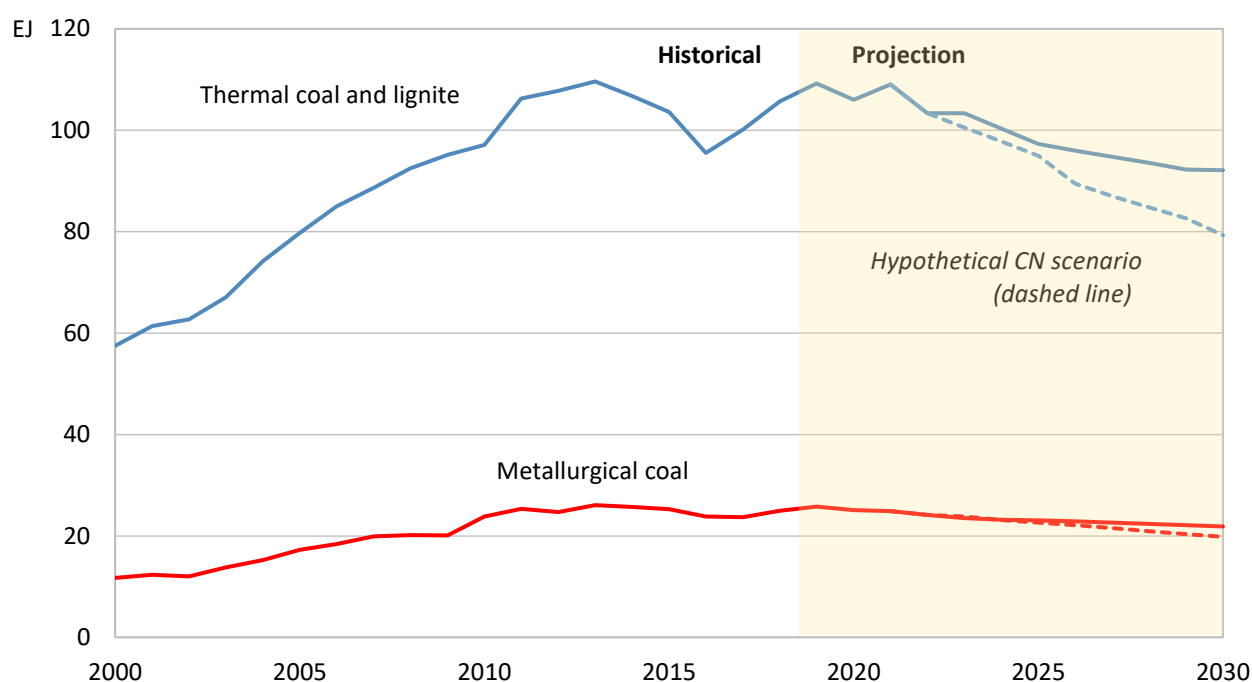

Source: compiled by the authors based on EGEDA (2021) and APEC Outlook 8th (2022).

Key points

- In the Reference Scenario (REF), APEC-wide coal production is projected to fall by 13% in 2030 relative to 2018. The decline in thermal coal production occurs at a faster pace than for metallurgical coal.
- The difference in the pace of decline is due to many APEC economies developing and deploying fuel-switching strategies (to natural gas and renewables) to achieve greater emissions reduction from electricity generation. However, fuel switching is not viable for metallurgical coal consumption.
- In the CN scenario, APEC coal production falls by 24% for the 2018-2030 period. Recent commitments and policies regarding coal phase-out policies, renewables, fuel switching, and low CO₂ emission coal combustion technologies are more ambitious than those assumed in the REF scenario for most APEC economies. If those commitments and policies are realized, the outlook for APEC coal production will likely to be closer to the CN projection.
- Thermal coal production falls faster in the CN scenario than in the REF, while metallurgical coal production remains robust in the medium term due to high steel demand. There is potential to switch to innovative new steel production technologies that do not rely on metallurgical coal, though most of these alternatives will not be available at scale until after 2030.

Thermal coal

Figure 3.7: APEC thermal coal (including lignite) production by economy: history and outlook

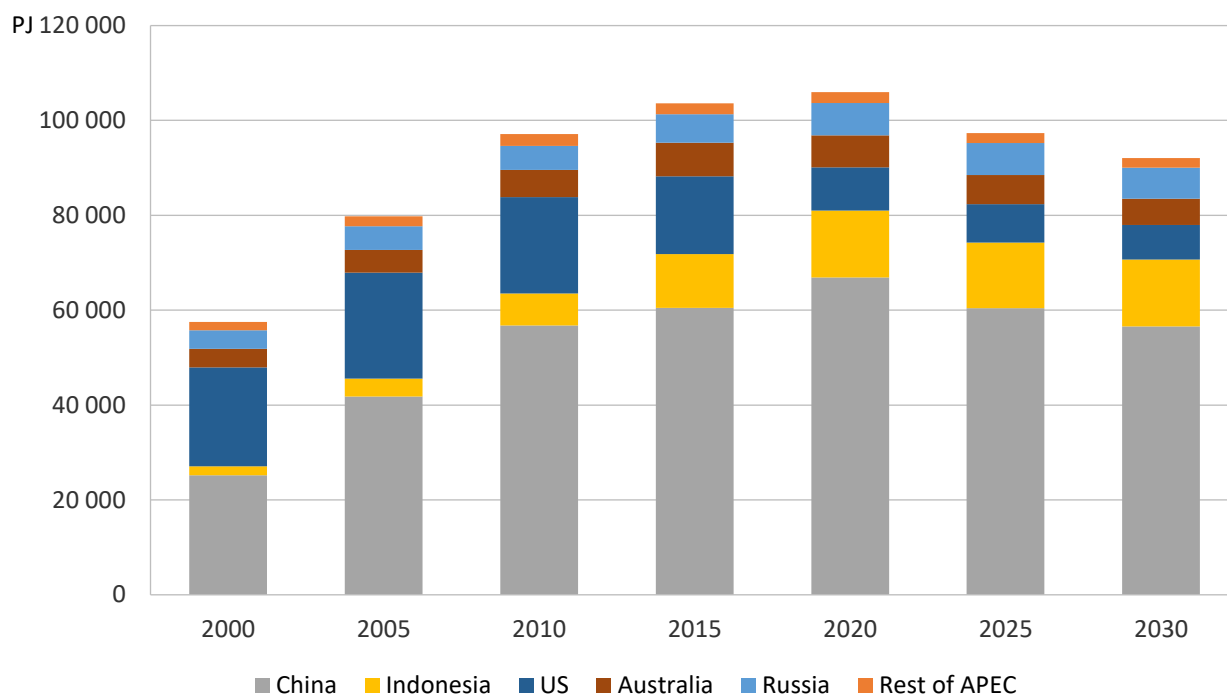

Source: compiled by the authors based on EGEDA (2021) and APEC Outlook 8th (2022).

Key points

- APEC thermal coal production in REF is expected to decline by 16%, from 109 EJ in 2019 to 92 EJ in 2030. The largest drops are projected to be in the US, followed by Australia, Russia, and China. In contrast, thermal coal production in Indonesia is forecast to grow.
- With rising concerns over pollution and CO₂ emissions from coal-fired power plants in China, thermal coal production growth is projected to slow noticeably through 2030. China reduced the coal share in the total generation mix from 77% in 2010 to 67% in 2018 (EGEDA, 2021). This decreasing trend is expected to continue during the forecast period, falling to 39% by 2030.
- Indonesia's thermal coal production is expected to grow by 3% over the 2019 to 2030 period. This projected production growth will indicate Indonesia as the second-largest producer of thermal coal in APEC.
- In Canada, the Alberta government is investigating the possibility of increasing coal production capacity for export. However, the Federal Government has introduced significant policy hurdles for thermal coal development. The new policy requires that a sitting Cabinet minister consider the impact of thermal coal mining on lifecycle emissions. This is likely to limit future thermal coal production increases in Canada.

Metallurgical coal

Figure 3.8: APEC metallurgical coal production by economy: history and outlook

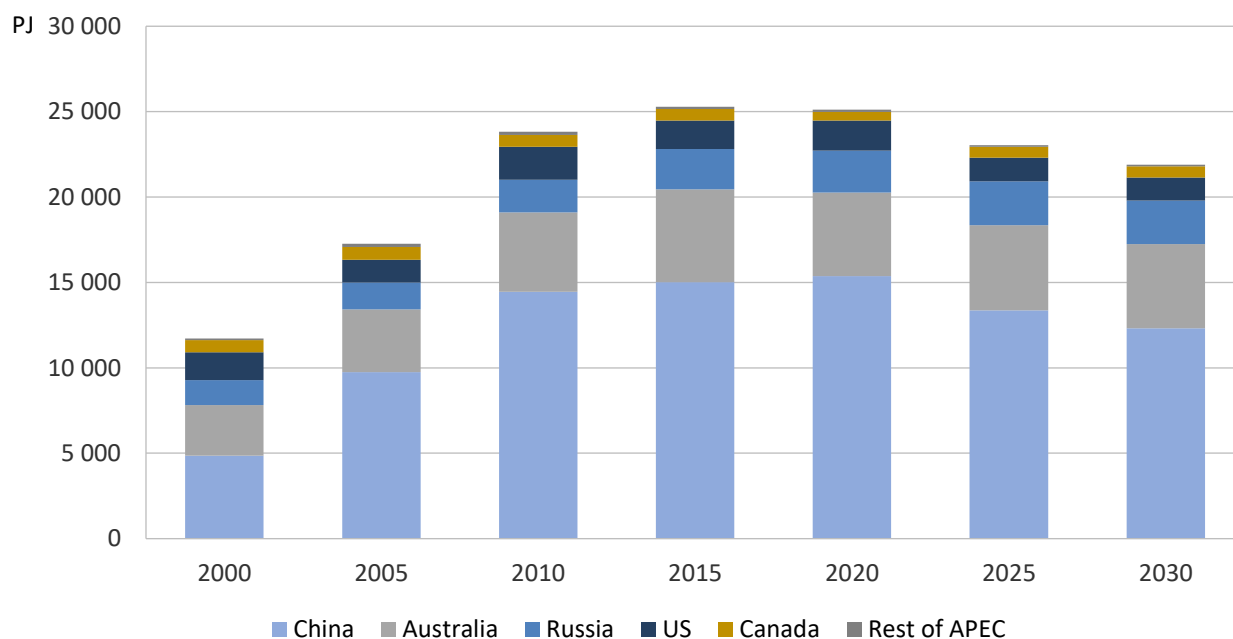

Source: compiled by the authors based on EGEDA (2021) and APEC Outlook 8th (2022).

Key points

- APEC metallurgical coal production in REF is projected to decline from 25 EJ in 2019 to 22 EJ in 2030, led by declines in the United States (-34%), Canada (-18%) and China (-13%). Australia and Russia are projected to post a small reduction in metallurgical coal production by 2030.
- In the short term, demand for metallurgical coal used in blast furnace steelmaking continues to rise due to strong growth in steel production. Meanwhile, the substitution of metallurgical coal with other fuels in the steelmaking industry is still constrained by technical issues. Therefore, metallurgical coal production is expected to decline in the medium and long term but at a slower pace than thermal coal.
- Almost all of China's metallurgical coal production is used by its domestic steel industry. A softening steel production outlook drives the projected decreasing trend out to 2030 over the medium to longer term. However, China is still expected to be the largest metallurgical coal producer in the APEC and the world in 2030, accounting for 56% of the total APEC metallurgical coal production.
- Metallurgical coal production in Australia is estimated to rebound strongly in 2022. However, in the medium- to long-term, both Australian and Russian metallurgical coal production is expected to post small declines.

APEC coal reserves

Figure 3.9: APEC coal reserves and R/P ratio of the top five APEC coal producers⁹, 2020

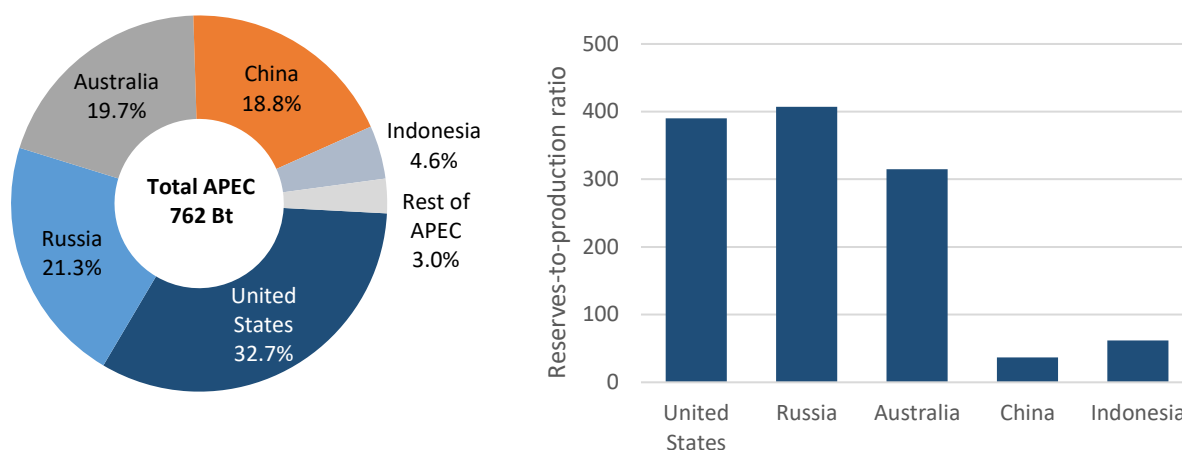

Source: compiled by the authors based on BP (2021) and U.S. EIA (2021).

Key points

- APEC economies accounted for 71% of global proved coal reserves in 2020 (BP, 2021), with 762 billion tonnes (Bt). The United States, Russia, Australia, China, and Indonesia hold over three-quarters of APEC proved coal reserves, which is 97% of the total APEC-wide coal reserves.
- The vast coal reserves located in the United States (249 Bt, 32.7%) are distributed among three main regions: Appalachian, the Midwest, and the West.
- Russia ranked second in proven coal reserves behind the United States (162 Bt, 21.3%). Its major coal reserves include the Donetskii coal fields in Moscow, the Pechora basins in Western Russia, and the Kuznetski, Kansk-Achinsk, Irkutsk, and South Yakutsk basins in Eastern Russia.
- Australia holds the third rank on a global and APEC basis (150 Bt, 19.7%). Australia holds black coal (including anthracite, bituminous and sub-bituminous) and brown coal (lignite). Black coal reserves are in New South Wales, Queensland, South Australia, Tasmania and Western Australia, while brown coal is found in South Australia, Western Australia, Tasmania, Queensland and Victoria (Geoscience Australia).
- China's 143.2 Bt of proven coal reserves accounted for over 18.8% of total APEC coal reserves. Deposits of anthracite, bituminous, sub-bituminous and lignite are mainly located in the north and north-west regions.
- Indonesia holds approximately 35 Bt, accounting for 4.6% of APEC's total proven coal reserves, with deposits mostly located in South Sumatra, East Kalimantan, and South Kalimantan.
- The United States, Russia, and Australia have reserves that are multiple hundreds of years of current production. China's very high current production levels, combined with lower reserves, mean the R/P is significantly lower.

⁹ The reserves-to-production ratio represents the number of years that current reserves would last if the production remained constant.

Chapter 4: Coal trade

Figure 4.1: Change in thermal coal exports from major APEC coal exporters

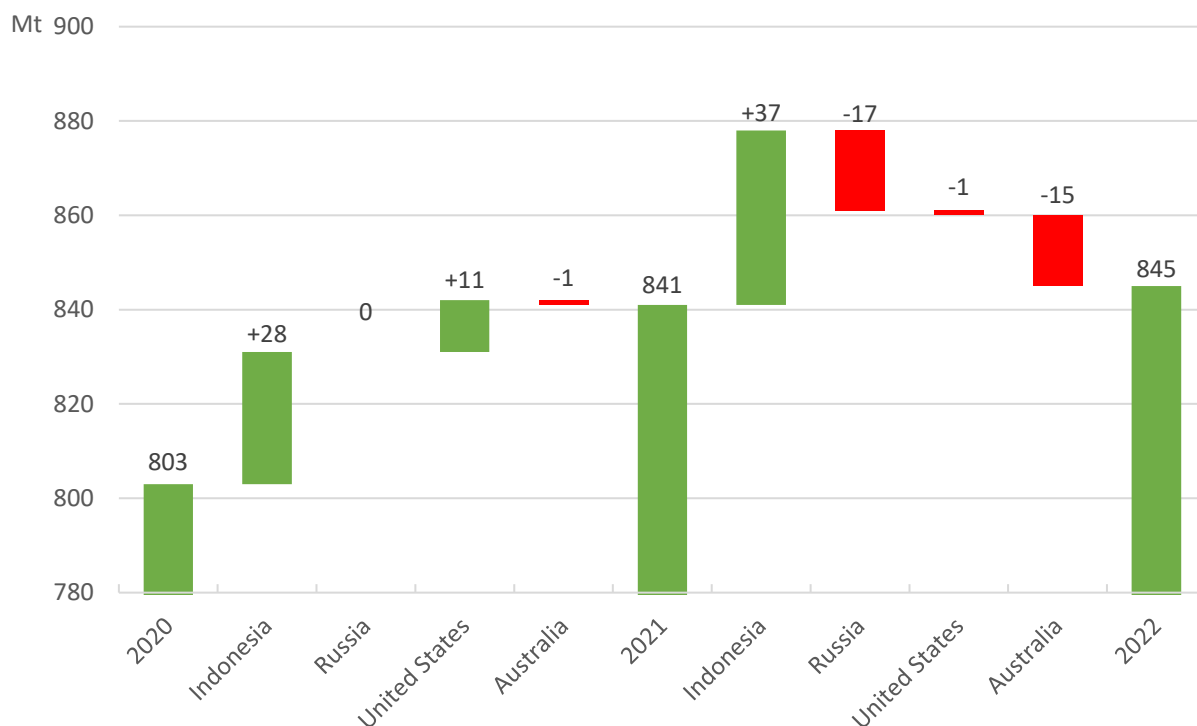

Source: compiled by the authors based on IEA (2023a) and IEA (2023b).

Key points

- A rapid economic recovery led to a surge in coal demand worldwide in 2021. Economies met the surge by increasing domestic coal production and/or increasing coal imports. Indonesia, Australia, Russia, and the United States are the major thermal coal exporters in the APEC region, accounting for approximately 98% of thermal coal exports.
- In 2021, Indonesia increased its thermal coal exports by 28 Mt to 432 Mt, exporting more than twice as much as Australia (199 Mt). The United States increased coal exports by 11 Mt to 36 Mt. Russia's thermal coal exports were the same in 2020 (174 Mt), while Australia's coal exports dropped by 1 Mt in 2021.
- Trading flows had already shifted since 2020, when China banned Australia's coal imports, but it changed further after February 2022 due to the Russian-Ukraine conflict. Russia experienced the largest drop in coal exports in 2022 (-17 Mt) due to international sanctions and coal import bans by Western economies. Australia's coal exports declined by 15 Mt in 2022 because of the floods in New South Wales and Queensland, which led to a declaration of force majeure at the Port Kembla Coal Terminal (Australian Government, 2022).
- In 2022, Indonesia increased exports by 37 Mt, a unique economy among APEC coal export economies in 2022.

Figure 4.2: Change in metallurgical coal exports from major APEC coal exporters

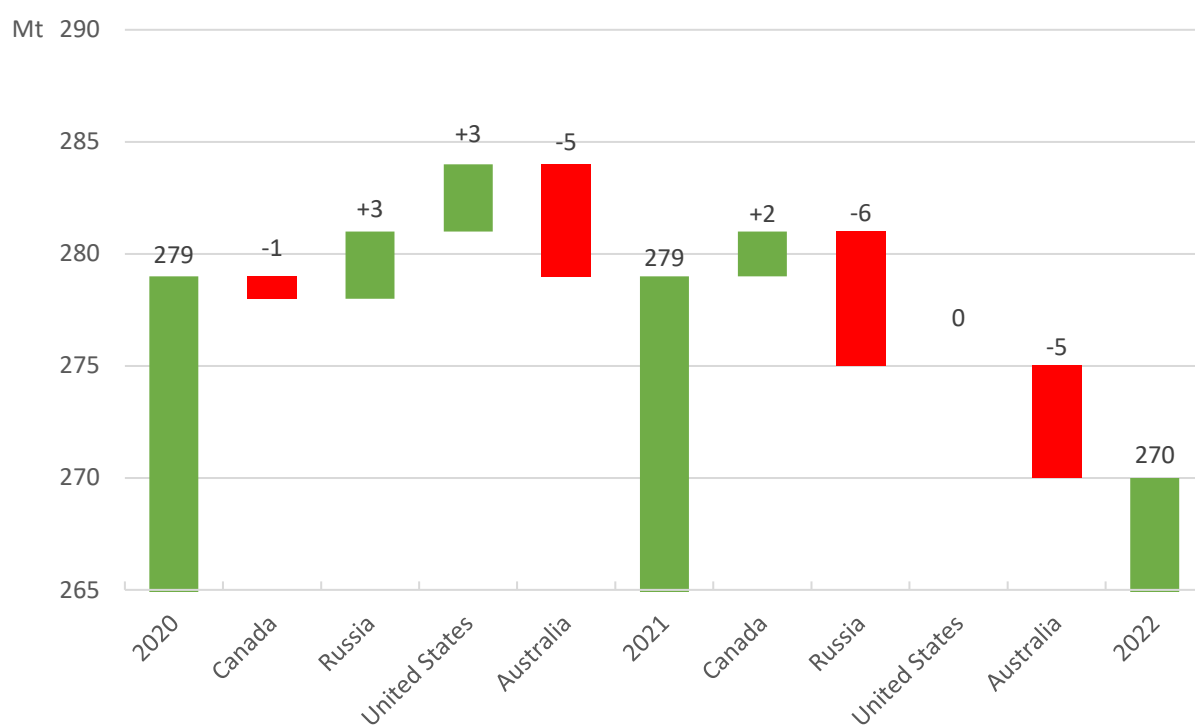

Source: compiled by the authors based on IEA (2023a) and IEA (2023b).

Key points

- In 2021, the lower metallurgical coal exports in some Australian coal mines (-5 Mt) and Canada (-1 Mt) were offset by higher exports from Russia (+3 Mt) and the United States (+3 Mt).
- Australia's metallurgical coal exports dropped dramatically in 2021 due to an unofficial Chinese ban on Australian coal. Although Australia shifted to other economies, this volume did not offset the export volume loss to China (IEA, 2022).
- Canada's metallurgical coal exports dropped by 1 Mt in 2021 due to lower metallurgical coal production.
- In 2022, Canada's metallurgical coal exports increased (+2 Mt), driven by the reopening of a 2 Mt metallurgical coal mine in Western Alberta, which was closed in response to the COVID-19 pandemic (IEA, 2022), while the United States maintained the metallurgical coal exports at the 2021 level (41 Mt).
- After the Russian-Ukraine conflict started in February 2022, Western countries refused to buy Russian coal, causing metallurgical coal exports to fall by 6 Mt in 2022. Although Russia has shifted the metallurgical coal trading flow to China, India and other Southeast countries, the increase did not fully offset the loss of markets in Europe, Japan and Korea.
- Metallurgical coal exports from Australia fell by 5 Mt in 2022. There were several reasons, such as unprecedented high coal prices, weather issues impacting coal supply and a drop in global steel production.

APEC thermal coal trade

Figure 4.3: Thermal coal imports and proportion of thermal coal imports to thermal coal consumption

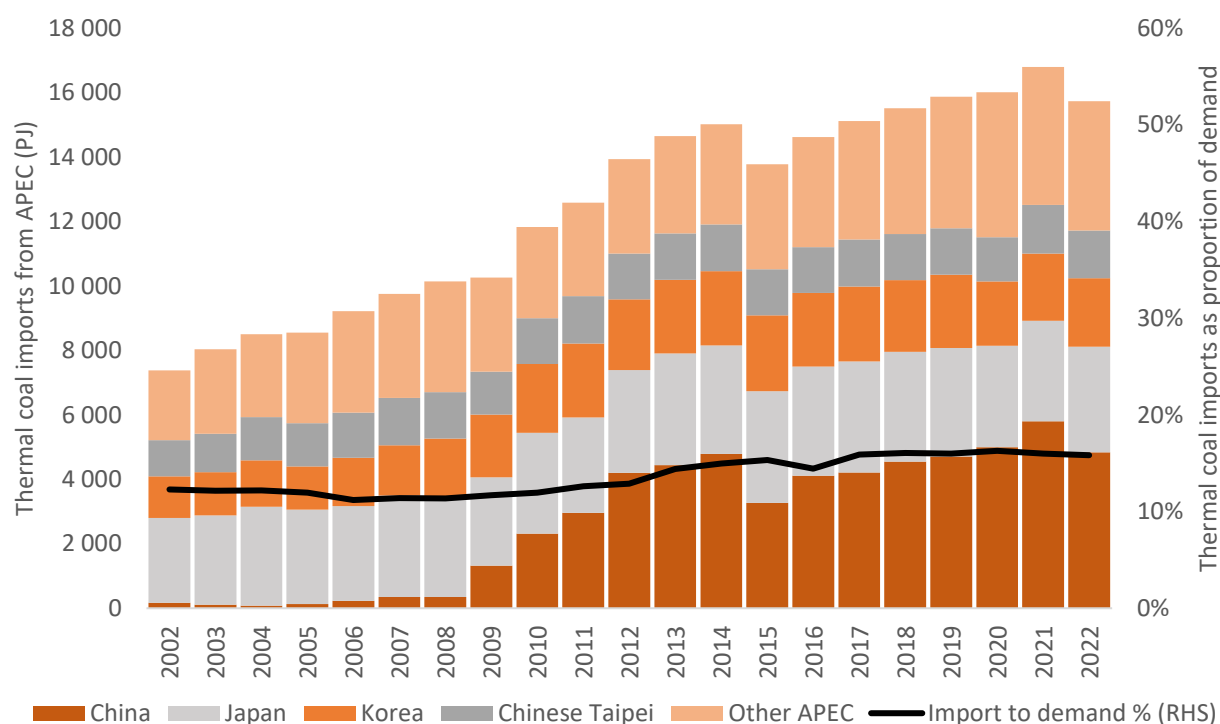

Source: compiled by the authors based on IEA (2023).

Key points

- APEC economies have increased imports of thermal coal since 2015, even though imported volume barely increased in 2020 due to the impacts of the pandemic. In 2021, thermal coal imports rebounded after many COVID-19 measures were lifted. However, thermal coal imports dropped considerably in 2022, close to the 2019 level.
- China has significantly ramped up its thermal coal imports since 2009, when it could no longer satisfy its domestic demand. Japan, Korea, and Chinese Taipei have consistently imported thermal coal for over two decades. In 2022, China’s demand for imports dropped because the Government was looking to lower its dependence on coal imports and meet most of its requirements through domestic production. The reduction in imports coincided with rising global thermal coal prices (S&P Global, 2023).
- APEC thermal coal imports as a proportion of APEC thermal coal consumption was 14% in 2022, steadily increasing from 12% in 2002. This shows that APEC thermal coal-consuming economies have increasingly relied on overseas sources to meet their demand.

Figure 4.4: Thermal coal exports and proportion of thermal coal exports to thermal coal production

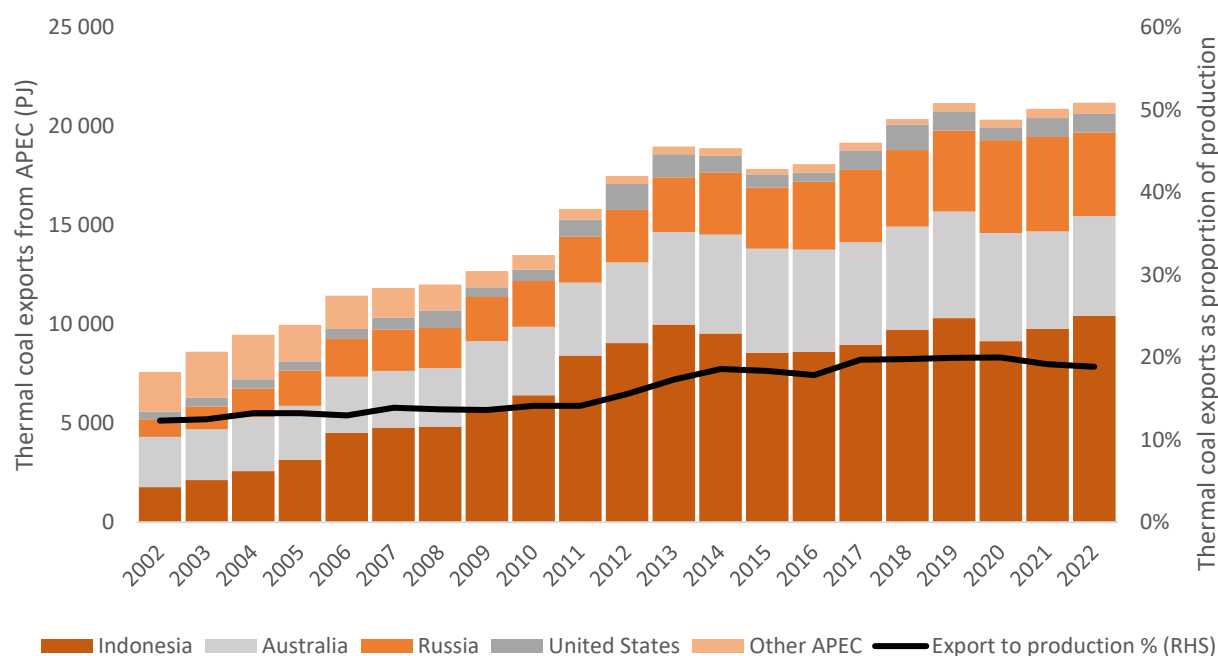

Source: compiled by the authors based on IEA (2023).

Key points

- APEC thermal coal imports were 15.7 EJ in 2022, significantly lower than the 21.2 EJ of thermal coal exports from APEC thermal coal producers. Indonesia has ramped up its thermal coal exports significantly over the last two decades, accounting for approximately 47% of APEC thermal coal exports in 2022. Australia is the next most prominent thermal coal exporter, accounting for approximately 24% of APEC thermal coal exports in the same year.
- These exports were predominantly headed to other APEC economies, though significant volumes were also destined for non-APEC economies, such as India. Notably, China imposed import bans on Australian thermal coal at the end of 2020, so the proportion of thermal coal that would typically be headed to China, moved instead to alternative markets. China relied on alternative thermal coal producers to meet its supply requirements. This presents challenges in situations where supply is constrained, such as the case in the latter half of 2021, exacerbated by rapidly increasing demand. China allowed multiple Australian thermal coal shipments to clear customs in September 2021 (FT, 2021).
- APEC thermal coal exports as a proportion of APEC thermal coal production was 17% in 2022. This has increased from 13% in 2002, though it shows that most APEC thermal coal production is consumed domestically (83%). This APEC-wide statistic is mostly driven by China's pattern of overwhelming domestic consumption.

APEC metallurgical coal trade

Figure 4.5: Metallurgical coal imports and proportion of metallurgical coal imports to metallurgical coal consumption

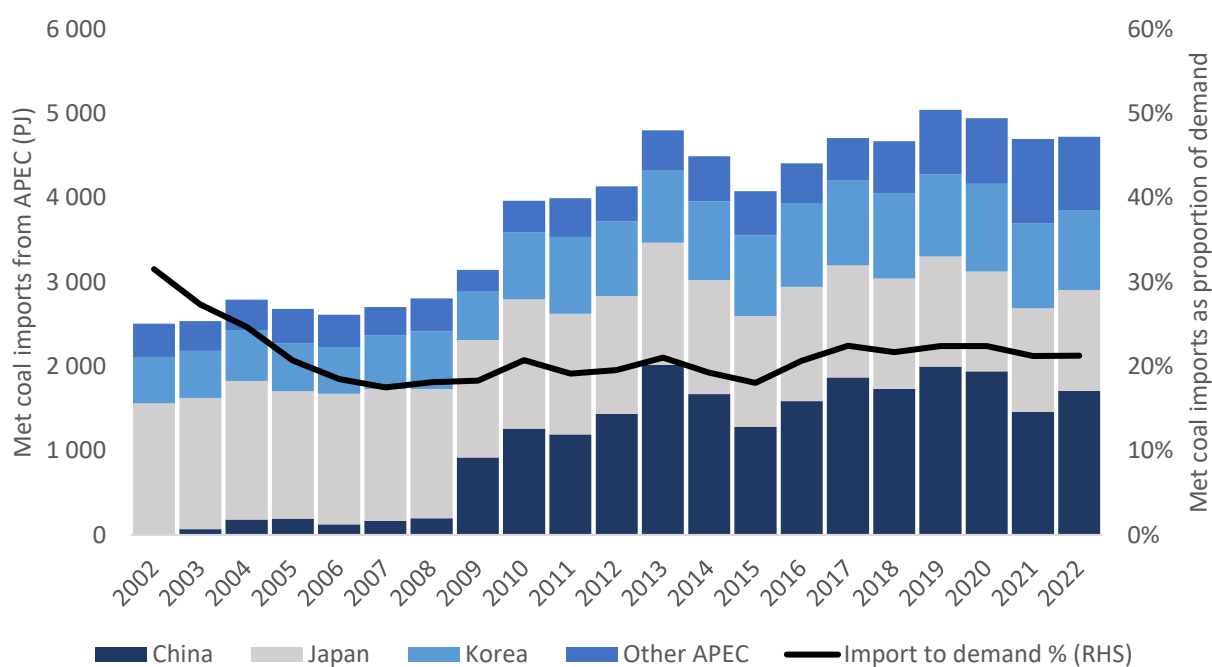

Source: compiled by the authors based on IEA (2023).

Key points

- The quantity of metallurgical coal trade is significantly lower than the thermal coal trade on an energy content or weight basis. Historically, the market for thermal coal has been at least three to four times larger. Metallurgical coal imports peaked at 5.0 EJ in 2019 and declined to around 4.7 EJ in 2022.
- China is the largest metallurgical coal importer, significantly ramping up its metallurgical coal imports since 2009, given that its domestic resources were insufficient to meet the needs of its rapidly growing steel industry. However, a big drop in metallurgical coal import was seen in 2021 due to the ban on coal import from Australia and limited supply from Mongolia due to surging COVID-19 cases in Mongolia (China Macro Economy; Argus, 2022). In 2022, metallurgical coal imports rebounded to the 2018 level.
- Japan is still a major metallurgical coal importer, accounting for a quarter of APEC metallurgical coal imports. However, the volume of metallurgical coal imported by Japan has declined from a peak of 1.6 EJ in 2004 to 1.2 EJ in 2022.
- Korea is the other major APEC metallurgical coal importer, with nearly 1.0 EJ imported in 2022.
- APEC metallurgical coal imports as a proportion of APEC metallurgical coal consumption have fluctuated around 21% for over a decade, having fallen from 32% since 2002.

Figure 4.6: Metallurgical coal exports and proportion of metallurgical coal exports to metallurgical coal production

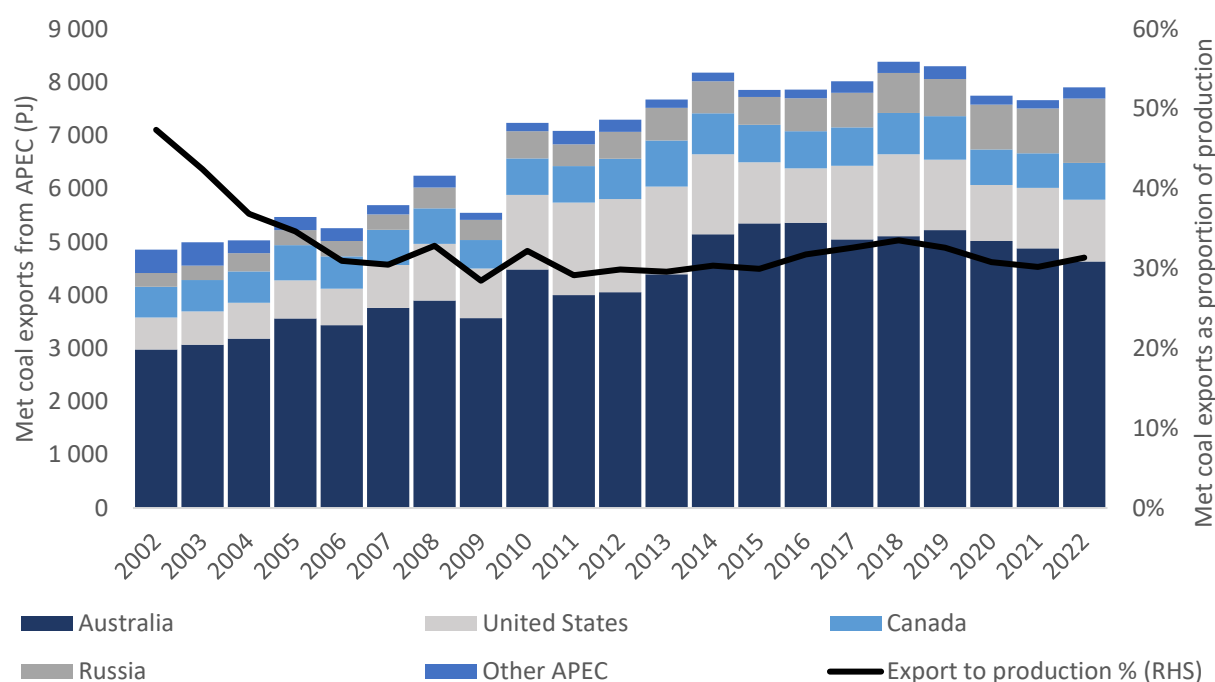

Source: compiled by the authors based on IEA (2023).

Key points

- APEC metallurgical coal exports rose to 7.9 EJ in 2022 from 7.6 EJ in 2021. Australia is by far the largest metallurgical coal exporter in APEC, with an approximately 60% share. Russia, the United States, and Canada are the next most prominent metallurgical coal exporters, accounting for 15.3%, 14.7%, and 8.8% of APEC metallurgical coal exports in 2022, respectively.
- In 2022, Australia exported 4.6 EJ of metallurgical coal, accounting for approximately 58.6% of APEC metallurgical coal exports. Even with smaller export volumes than thermal coal exports, metallurgical coal exports brought more revenue to the Australian Government.
- APEC metallurgical coal producers exported 31% of their production in 2022. This portion is down from a high of almost 50% of production destined for export near the beginning of the millennium.

APEC coal trade projections

Figure 4.7: APEC coal imports: history and outlook

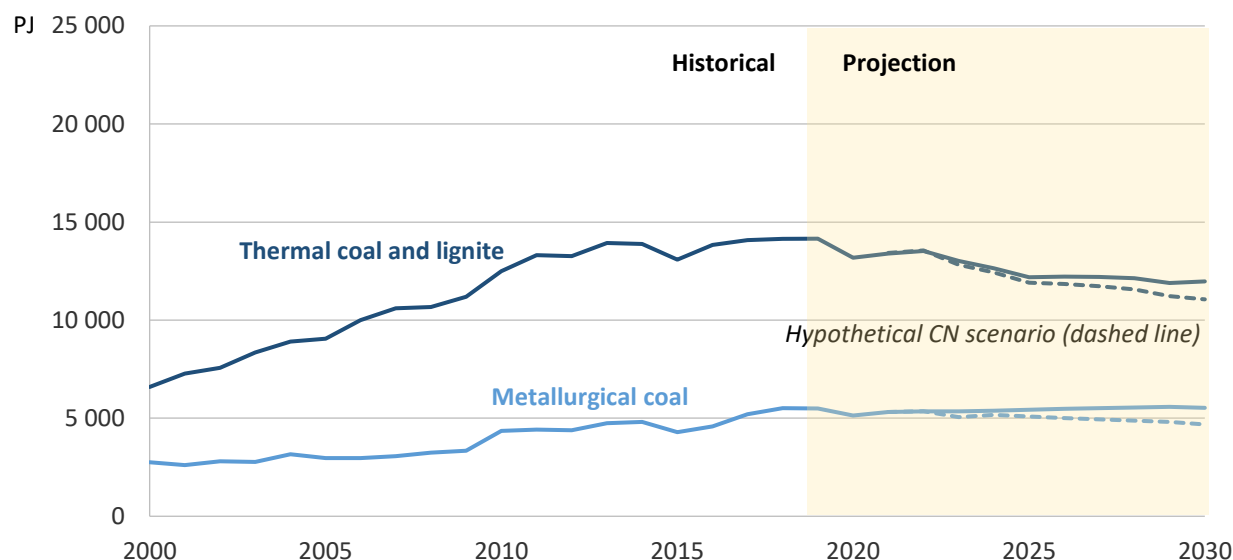

Source: compiled by the authors based on EGEDA (2021) and APEC Outlook 8th (2022).

Key points

- Coal import and export volumes are expected to rebound to pre-pandemic levels in 2021. However, the current large coal price spikes brought on by surging economic growth and supply disruptions mean that the magnitude of the rebound is uncertain.
- Moving beyond the short-term volatility brought on by the pandemic, the APEC Energy Demand and Supply Outlook 8th Edition 2022 estimates that thermal coal imports will decline slowly while metallurgical coal imports will increase slowly out to 2030. Assumed robust steel production explains metallurgical coal's resilience. The decline in thermal coal imports aligns with the planned move away from coal for power generation in many APEC economies.
- In a hypothetical CN scenario, APEC thermal coal imports will fall away more rapidly. APEC metallurgical coal imports will also fall due to greater material efficiency (less demand for steel) and improved scrap utilisation (recycling). While thermal coal consumption will fall, there is support from southeast Asia APEC economies, such as Thailand, Viet Nam and Malaysia, that will continue to rely on thermal coal imports to meet the supply for newly constructed coal-fired power plants.
- Regulations and policies related to coal mining activities are also likely to support coal imports. In some APEC economies, carbon taxes, environmental protection legislation, and post-mining flora rehabilitation significantly increase the cost of domestic coal production. For these economies, imported thermal coal may be the most cost-competitive supply source, even when domestic reserves are significant.

Figure 4.8: APEC coal exports: history and outlook

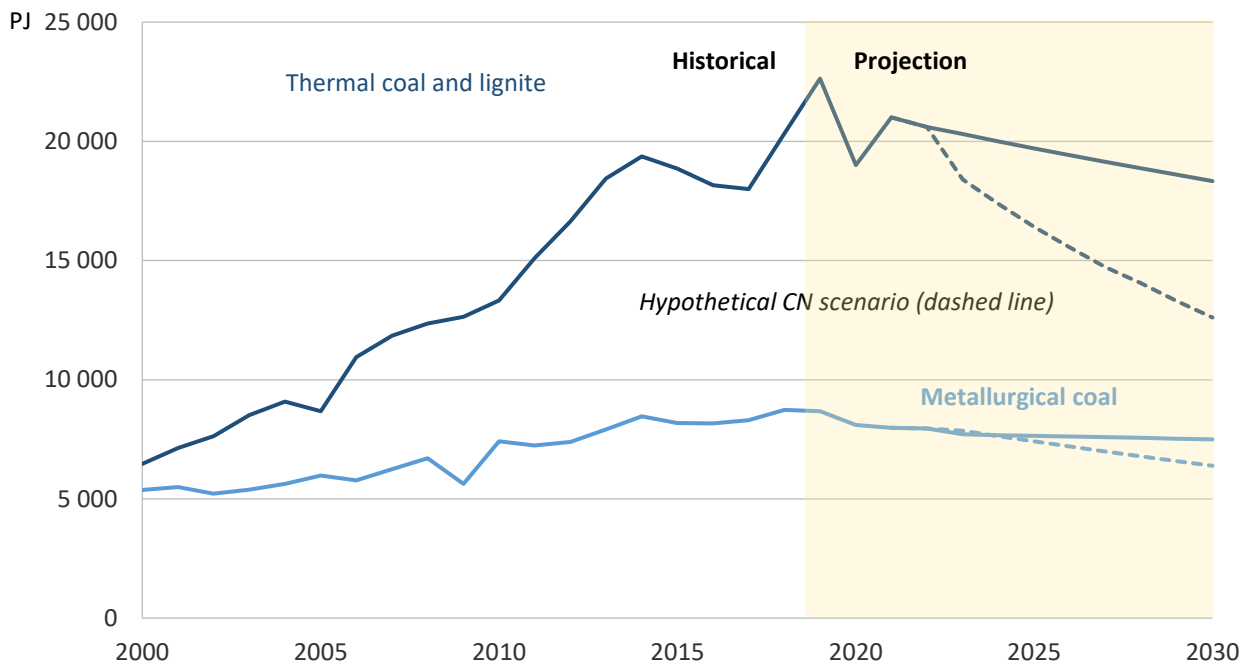

Source: compiled by the authors based on EGEDA (2021) and APEC Outlook 8th (2022).

Key points

- APEC coal exports are significantly larger than APEC coal imports. The figure shows that there will be a slow decline in APEC thermal coal exports in the REF scenario as APEC thermal coal producers begin to slow their production due to declining global demand. APEC metallurgical coal exports will maintain a more robust level to meet supply requirements for large steel-producing economies.
- In the hypothetical CN scenario, thermal coal exports are expected to fall dramatically by 2030. In this scenario, the assumed rapid movement world-wide away from coal-fired power means less global demand for coal. Metallurgical coal exports declined marginally due to material efficiency and the use of a higher proportion of scrap in steel production mentioned above.

Chapter 5: Prices and costs

Coal prices

Figure 5.1: Newcastle benchmark thermal coal spot prices, January 2019 to December 2023



Source: compiled by the authors based on Trading Economics.

Key points

- Following the initial COVID shock in early 2020, subsequent soft coal demand caused prices to dip below USD 50 per tonne.
- In 2021, the COVID pandemic led to a significant increase in global demand for goods, partly driven by the absence of consumer access to services, such as travel and hospitality. China's immense industrial sector responded by increasing production through most of 2021, which led to a very large increase in thermal coal demand for industry. Therefore, thermal coal prices started to rise and reached a peak in October 2021.
- In 2022, the impacts of sanctions against Russia due to the Russian-Ukraine war drove thermal coal prices to another record high of USD 420 per tonne on 9 March 2022. With the measures to stabilise the global energy markets from developed countries, thermal coal spot prices softened briefly in April. However, Newcastle benchmark thermal coal spot prices surged again to the next record high of about USD 425 per tonne in May due to coal transportation disruption in Australia.
- In September 2022, an all-time record high of thermal coal spot prices occurred, reaching approximately USD 450 per tonne, nine times higher than the prices in September 2020. Strong thermal coal demand from APEC Northeast Asia economies such as Japan, Korea and Chinese Taipei caused the price surge. In addition, extreme weather in Australia in 2022 hindered the coal transportation route from coal mines to seaborne port, causing a decline in coal export volume.
- In 2023, thermal coal spot prices dropped dramatically from USD 400 per tonne in early 2023 to around USD 130 per tonne in July. In some of the last months of the year, thermal coal spot prices fluctuated at around USD 150 per tonne.

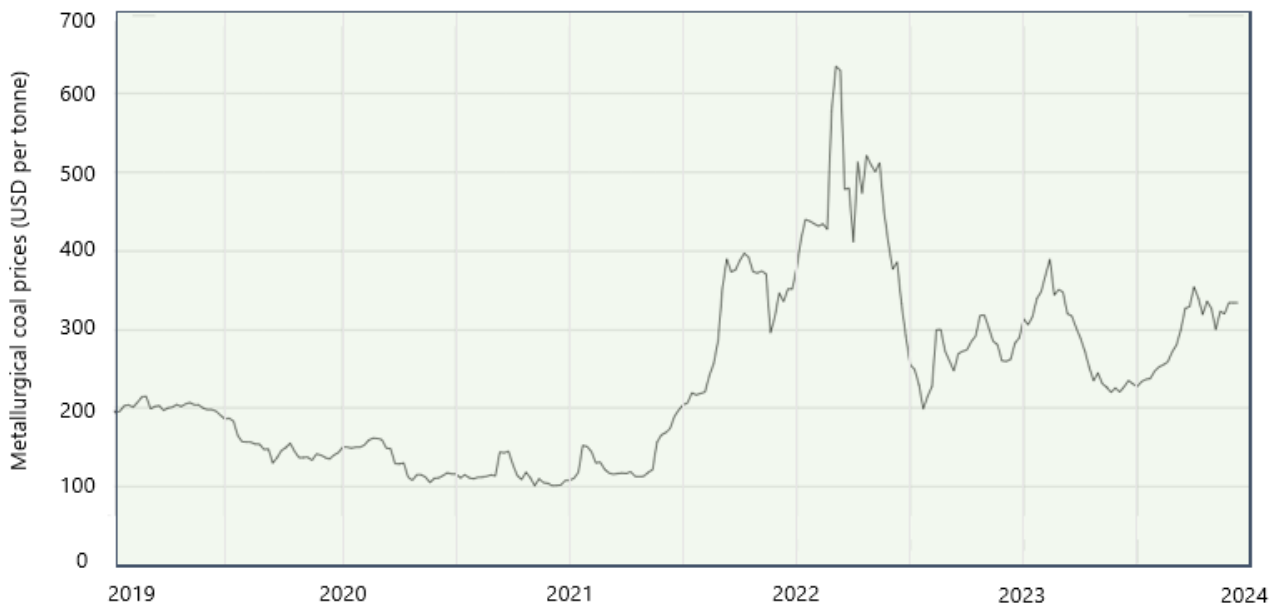
Figure 5.2: Australian premium hard coking¹⁰ coal spot price, January 2019 to December 2023

Source: compiled by the authors based on Barchart.

Key points

- In July 2021, coking coal spot prices had increased to over USD 200 per tonne. Part of this increase was due to strong European and Chinese demand, and part was from diminished supply (S&P Global, 2021).
- With the energy crisis coming to a head in China in September 2021, the Government compelled multiple steel producers to limit production temporarily. This had the dual impact of meeting the challenge of the energy crisis at the expense of economic growth and reducing emissions and pollution to meet environmental commitments by the Government. The fall in steel production has yet to translate to lower metallurgical spot prices, which spiked at around USD 400 per tonne at the beginning of October 2021.
- In early 2022, the Australian coking coal spot prices climbed up again, even before the Russian-Ukraine war. With the impact of the war and volatile energy prices, coking coal prices surged to an unprecedented level of about USD 630 per tonne on 21 March 2022. Coking coal prices then eased somewhat and remained at around USD 500 per tonne until the end of May.
- In June 2022, coking coal prices dropped again due to the weak demand from China's steelmaking industry. As a result, the Australian coking coal spot prices declined to USD 200 per tonne in August 2022.
- In the last quarter of 2022, coking coal spot prices rebounded to around USD 300 per tonne to a small extent, partly due to a met-to-thermal coal switch and high demand at the end of the year.
- In 2023, coking coal prices fell in net terms during the first quarter and eased further in June as Australian supply picked up, global steelmaking showed signs of softening, and strong post-COVID Chinese demand failed to emerge. The limited supply of Australian high-quality raw coking coal explains the price increase for coking coal in the third quarter.

¹⁰ "Coking coal" and "metallurgical coal" can be used as interchangeable terms.

Coal supply costs

Figure 5.3: Mining cost structure

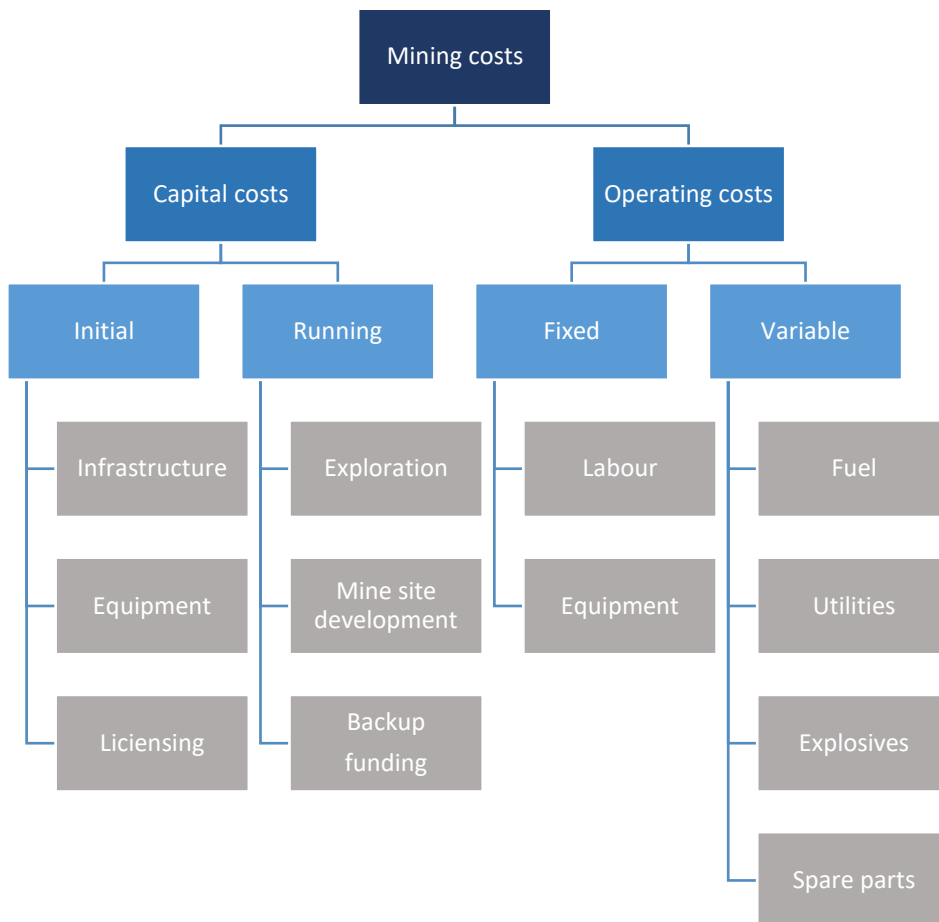

Key points

- The cost of producing coal comprises capital costs and operating costs. Capital costs can be further subdivided into initial costs and running costs. Initial costs relate to the purchase of mining-related equipment, construction, environmental compliance, and licensing rights. In contrast, running costs involve mine site development, exploration, and backup funding.
- Operating costs include fixed costs, such as labour and equipment, and variable costs, such as fuel, utilities, explosives, and spare parts. These are the day-to-day running expenses for a coal mine.
- Individual cost categories vary depending on mining methods, technology, labour expenses, and input commodities prices.

Thermal coal production cost

Figure 5.4: The share of high calorific value (CV) coal production by supply cost, 2019

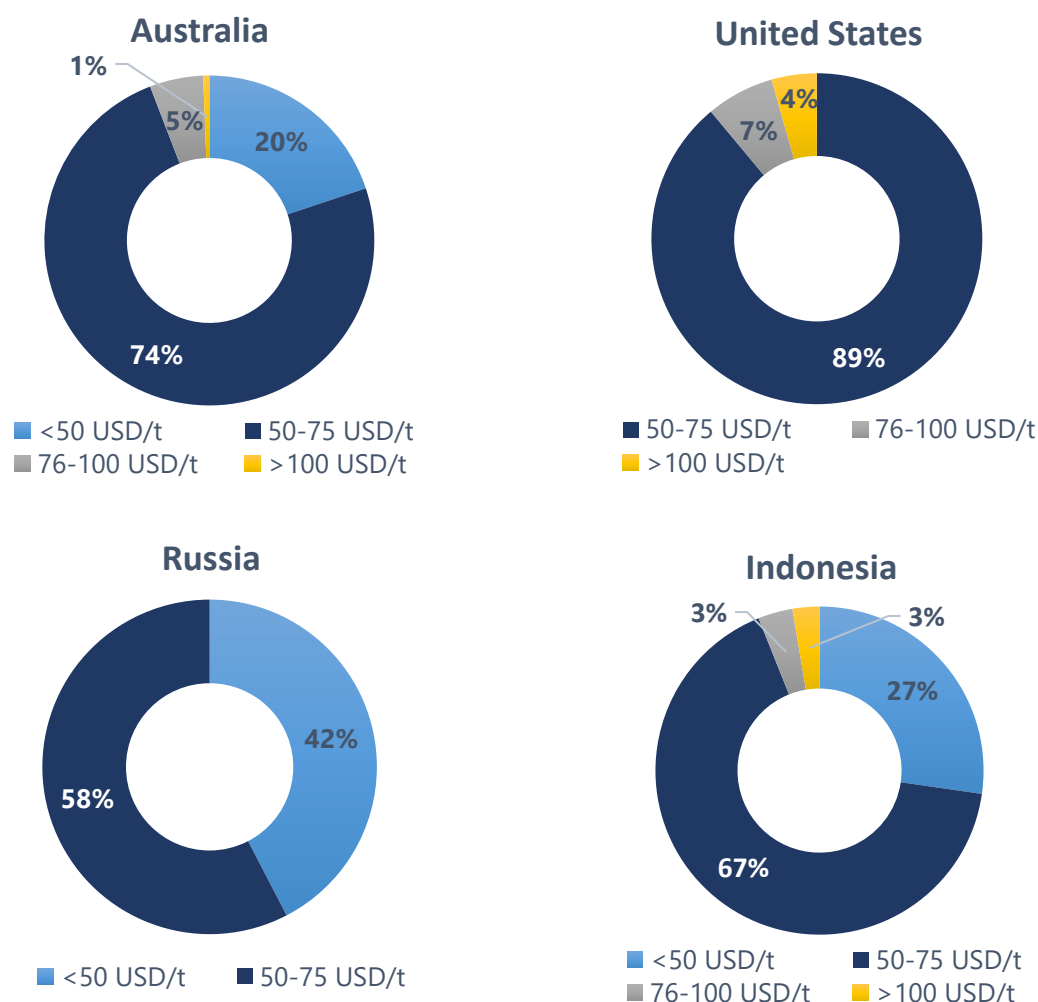

Source: compiled by the authors based on IEA (2020b).

Key points

- Production costs for high CV thermal coal in 2019 ranged from USD 35.5 to USD 150 per tonne, depending on the economy. Over half (58%) of Russia's high CV thermal coal production was produced at a cost between USD 50 and USD 70 per tonne, with the remainder (42%) costing less than USD 50 per tonne.
- Australia had a wider range of potential costs, though most (94%) high CV thermal coal production was produced for USD 75 per tonne or less. Indonesia could also produce 94% of its high CV thermal coal for USD 75 or less. Unlike Australia, Russia, and Indonesia, the US is unable to produce any of its high CV thermal coal for less than USD 50 per tonne. The US also had the highest proportion of mines with costs greater than USD 75 per tonne (11%).
- Thermal coal production costs might be slightly increased in recent years due to inflation in each economy. Cost inflation has become embedded in coal mining operations through increased labour costs, extreme weather events impacting production, elevated energy and consumable input costs, rising port costs, increasing strip ratios, higher financing costs, and government royalty hikes.

Metallurgical coal production cost

Figure 5.5: The share of metallurgical coal production by supply cost, 2019

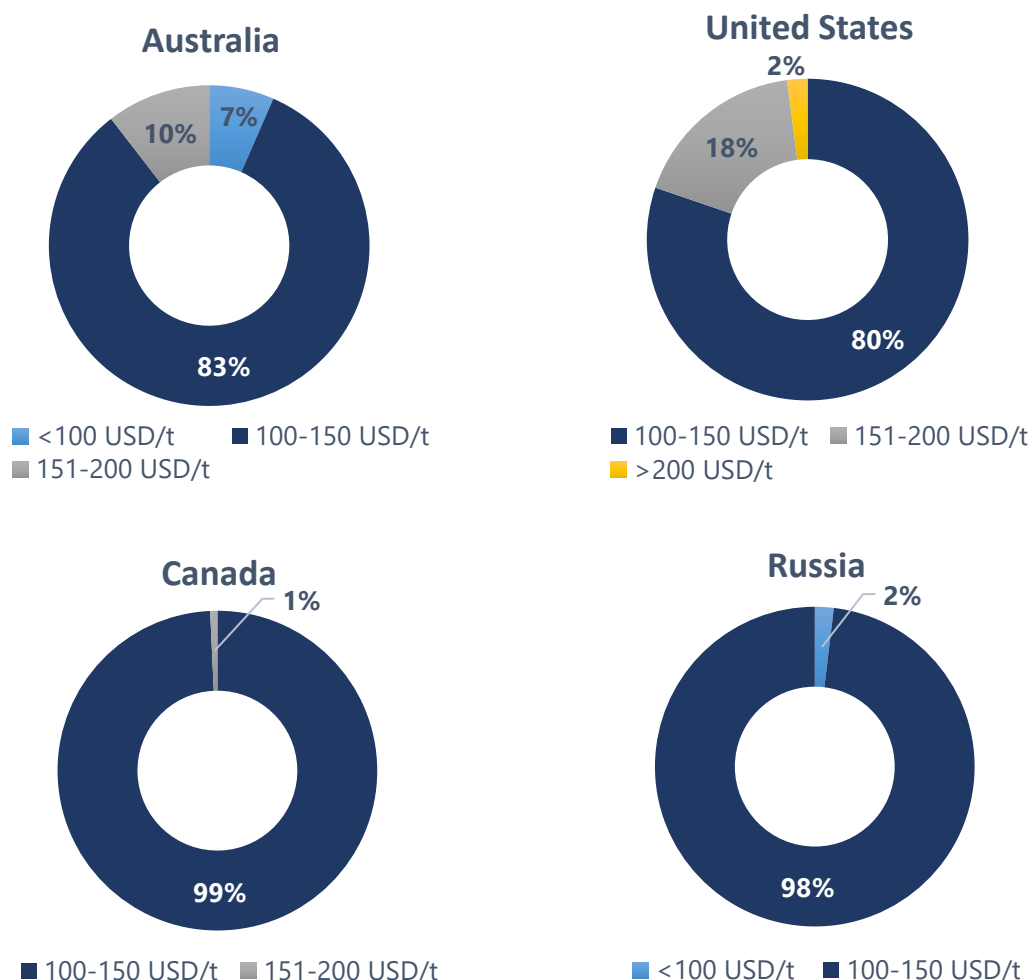

Source: compiled by the authors based on IEA (2020b).

Key points

- Metallurgical coal production costs ranged from USD 87 to USD 250 per tonne, free on board (FOB), in 2019. Labour, fuels, materials, taxes, royalties, inland transportation, and maintenance are all influential in the cost structure. The mining method (such as underground mining or opencast mining), location, and geological conditions are also important cost determinants.
- The above charts show the metallurgical coal production costs for Australia, the US, Canada, and Russia (IEA, 2020b). Mining costs largely fall into the USD 100 to USD 150 per tonne range. The US has the lowest proportion of suppliers able to produce coal at these costs (80%), followed by Australia (83%), Russia (98%) and Canada (99%). The fact that most production costs fall in a similar band reflects that the market for metallurgical coal is relatively competitive. If costs were significantly higher for certain producers, those higher-cost producers would eventually exit the market, leaving only those producers that can produce at a competitive cost. This analysis only looks at currently viable producers.
- Metallurgical coal production costs have slightly increased in recent years due to cost inflation.

Input factors influence supply costs

Figure 5.6: Average labour cost in main coal-producing economies in the APEC region, 2018-2020

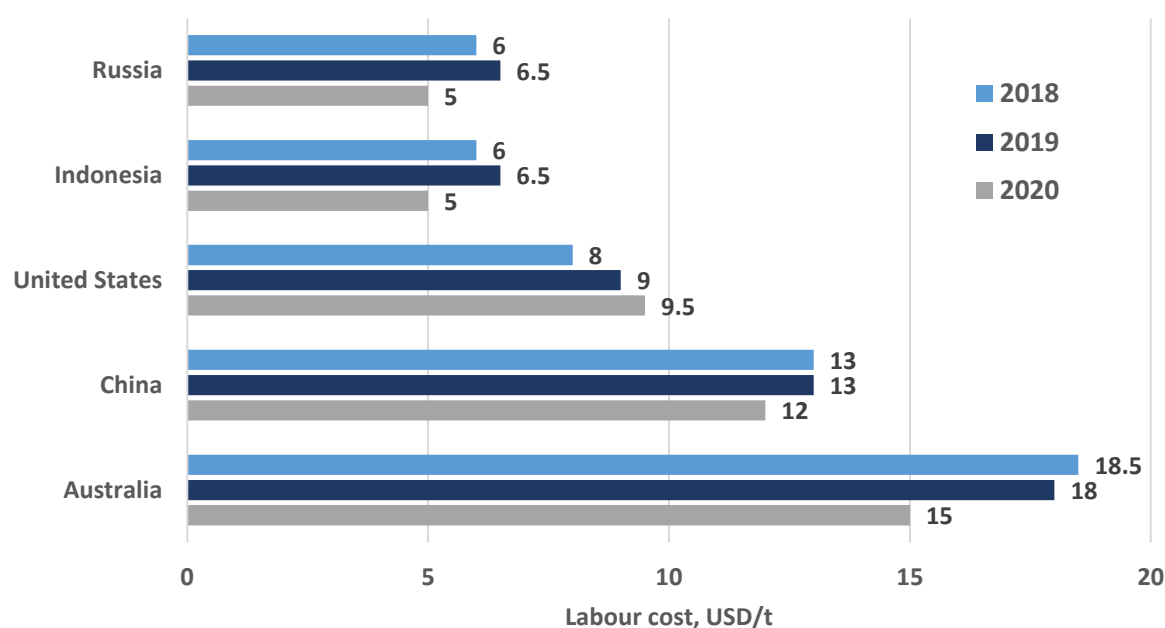

Source: compiled by the authors based on IEA (2020b).

Key points

- Many input costs, such as fuel costs, steel, explosives, and rubber products, are common for all mining and industrial enterprises. According to IEA data, explosives and tyre prices plateaued between 2018 and 2020, whereas steel products and diesel fuel costs were more volatile. Diesel costs are particularly influential, especially at opencast mines, due to the large amounts of fuel required to haul coal and overburden. Low diesel prices at the beginning of 2020 were a moderating cost factor in the face of low spot prices and lower output brought on by the pandemic (IEA, 2020b).
- Average labour costs vary from USD 5 to USD 18.5 per tonne in Australia, China, the United States, Indonesia, and Russia. Labour costs were relatively stable in 2018 and 2019, though reduced substantially in all APEC economies in 2020, except for the United States.
- Australia had the highest average labour cost in APEC in 2018 and 2019, with this falling by 17% in 2020 to USD 15 per tonne. China's labour costs were the second-highest in 2020, falling to USD 12 per tonne. Russia and Indonesia had identical labour costs and were the cheapest of the main APEC coal producers: USD 5 per tonne in 2020. The United States has seen a continuation in rising labour costs in 2020 to USD 9.5 per tonne.
- Australia had the highest labour cost proportion, accounting for 31% of total mining costs in 2019. Indonesia had the lowest labour cost-share, at 20% of total mining costs. While costs are influential in determining competitiveness, factors such as reliability of supply and production quality can justify a higher cost structure.

Chapter 6: Greenhouse gas emissions from the coal value chain

Carbon dioxide emissions

Figure 6.1: Coal-related CO₂ emissions in APEC and the rest of the world, 2011-2021

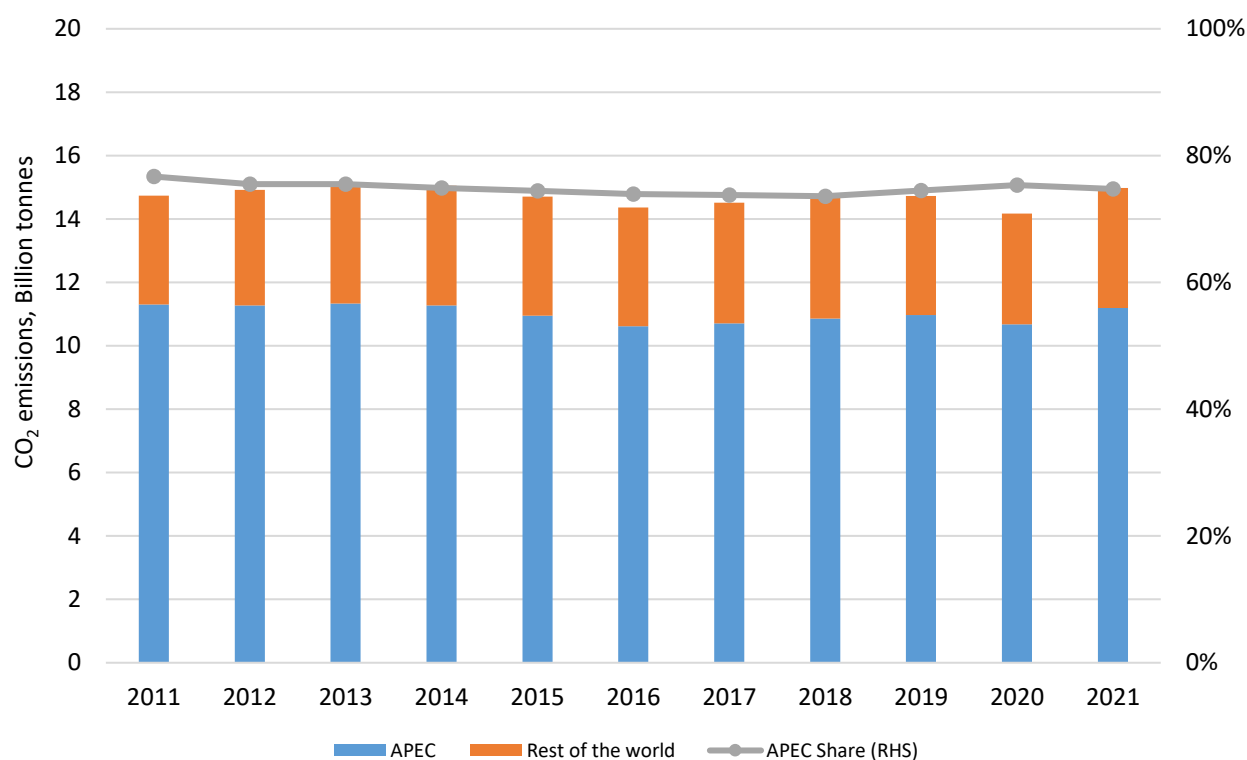

Sources: compiled by the authors based on Our World in Data.

Key points

- When coal is burned, the carbon in the coal combines with oxygen to form CO₂. One molecule of CO₂ is 3.67 times heavier than a molecule of carbon due to the additional weight of the two oxygen atoms. Basically, coal is not 100% of carbon. Therefore, burning a tonne of coal emits 2.07 tonnes of CO₂.
- CO₂ emissions from coal combustion processes in the APEC region accounted for around three-quarters of the global coal-related CO₂ emissions over the last decade because four APEC economies were often in the top five largest coal consumers worldwide for many years, including China, the United States, Japan and Indonesia.
- APEC coal-related CO₂ emissions plateaued at 11.3 Gt from 2011 to 2014, declined in 2015 through 2018 and increased again to 11.2 Gt in 2021 after a substantial drop in 2020. CO₂ emissions from coal were roughly proportional to the coal consumption profiles in each region.

Figure 6.2: CO₂ emissions from coal combustion in selected APEC economies in 2021

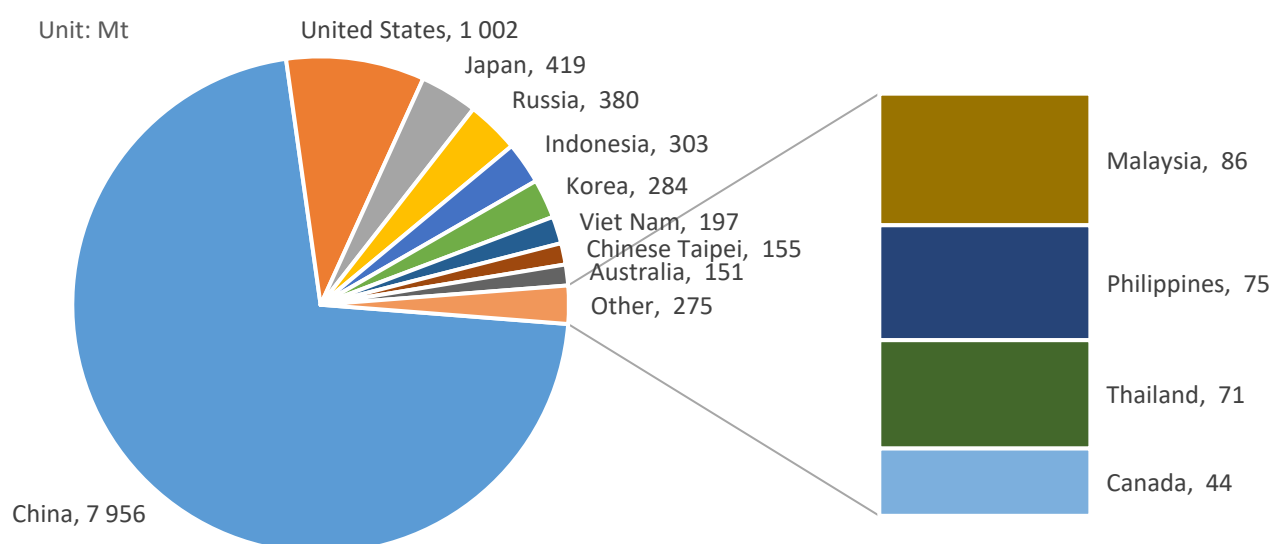

Sources: compiled by the authors based on Our World in Data.

Key points

- In 2021, APEC economies emitted 11.2 Gt of CO₂ from coal combustion processes, accounting for 74.7% of the global coal-related CO₂ emissions.
- China is the largest emitter, releasing 7 956 Mt, followed by the United States (1 002 Mt), Japan (419 Mt) and Russia (380 Mt).
- Indonesia and Korea emitted 303 Mt and 284 Mt in 2021, respectively.
- Viet Nam, Chinese Taipei, and Australia emitted around 500 Mt, while the next four largest economies emitted 275 Mt in 2021.

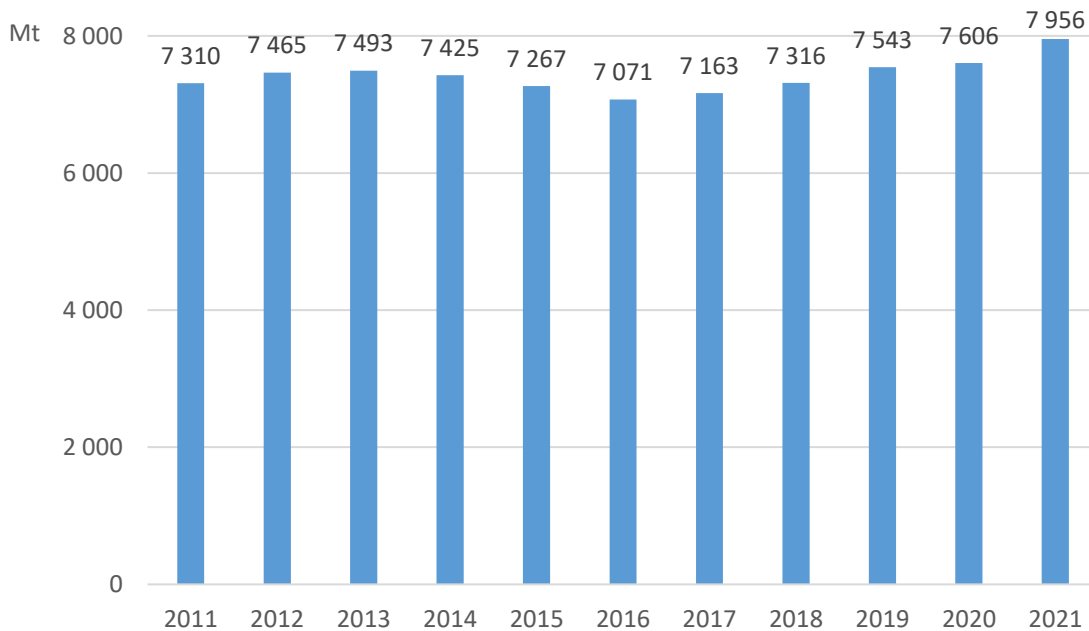
Figure 6.3: Coal-related CO₂ emissions in China

Sources: compiled by the authors based on Our World in Data.

Key points

- CO₂ emissions from coal-based plants reached a record high, approaching 8 Gt in 2021.
- Coal-related CO₂ emissions in China have risen gradually in recent years due to continued investment in new coal-based capacity in the steel and power sectors.
- The construction of coal-fired power plants is strongly supported by the central government. The National Energy Administration (NEA) has encouraged provinces to start the construction and operation of “supportive power sources” as fast as possible. A NEA official praised new coal plants at the press conference for providing strong support for guaranteeing electricity supply.
- China’s President Xi Jinping said in an October 2022 report to the Communist Party’s National Congress that the country would move faster to develop renewable and nuclear energy. But he also emphasized energy security - strongly signalling a continued reliance on coal, of which China has more reserves than any other country (The New York Times).

Methane emissions

Figure 6.4: Global methane emissions and sources of emissions, 2022

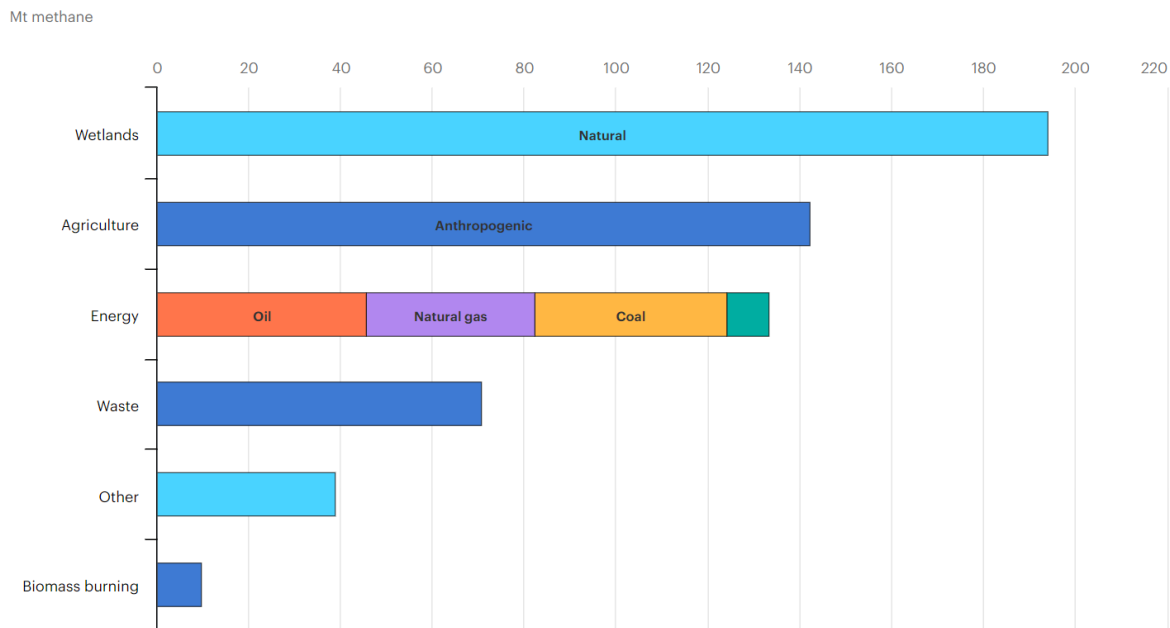

Source: IEA (2023d).

Key points

- Two key characteristics determine the impact of different greenhouse gases on the climate: the length of time they remain in the atmosphere and their ability to absorb energy. Methane has a much shorter atmospheric lifetime than CO₂ but absorbs much more energy while it exists in the atmosphere.
- According to IEA, the methane concentration in the atmosphere is currently over 2.5 times greater than its pre-industrial levels. The increase has accelerated recently; preliminary data indicate another significant annual increase in 2022 (IEA, 2023d).
- Estimates of methane emissions are subject to a high degree of uncertainty, but a recent assessment by IEA suggests that annual global methane emissions are around 580 Mt. This includes emissions from natural sources (around 40% of the total) and from human activity (around 60% of the total), also known as anthropogenic emissions (IEA, 2023d).
- The largest anthropogenic source is agriculture, which is responsible for around one-quarter of emissions, followed by the energy and waste sectors. In the energy sector, methane emissions from coal mines are similar to those from oil and gas fields. The IEA methane estimates show coal’s methane emissions in 2022 are 41.8 Mt, compared to 45.6 Mt from oil and 36.7 Mt from gas.

Figure 6.5: Sources of coal mine methane emissions



Source: Authors

Key points

- Coal seams naturally contain methane, which can be released during or after mining operations and is referred to as coal mine methane (CMM).
- Sources of CMM emissions include underground coal mines, open-pit coal mines, coal preparation plants and abandoned mines.
- In the open-pit coal mines, methane is released as coal seams are broken up and coal is extracted for processing.
- In underground mines, methane is mainly released into the atmosphere via mine ventilation system or “Ventilation Air Methane” with methane concentration often less than 2%. In gassy coal mines, methane is drained from target coal seams prior to mining operations because the gas is highly explosive and poses a significant safety risk. CMM emissions tend to be higher from underground mines than from surface mines, as deeper coal seams tend to contain more methane than shallower coal seams.
- Coal mine methane continues to be released for decades after mining stops, as the gas gradually permeates from the underground formations and escapes through disused mine shafts to the surface.
- A total of 41.8 Mt of CMM was released into the atmosphere in 2022, representing an estimated 10% of total methane emissions from human activity. Steam coal and lignite accounted for around 75% of CMM emissions, and coking coal for the remaining 25%. Underground mines were responsible for around 70% of emissions, and surface mines were responsible for the remainder. Emissions from abandoned coal mines are not included in these estimates but could represent a significant source of emissions.

Figure 6.6: Coal mine methane emissions in the selected APEC economies, 2022

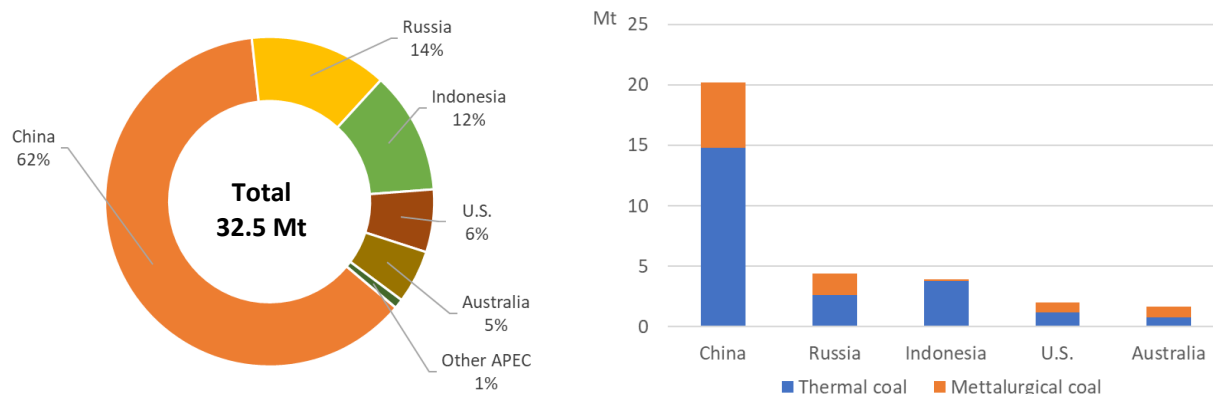

Source: compiled by the authors based on IEA (2023d).

Key points

- In 2022, APEC coal-producing economies released 32.5 Mt of methane during their coal mining activities, accounting for approximately 78% of the global CMM emissions (IEA, 2023d).
- The five largest coal mine methane emitters account for almost 99% of the total APEC CMM emissions. China is the largest emitter, corresponding to the large amounts of coal it produces, accounting for 62% of total APEC CMM emissions. Around three-quarters of Chinese CMM emissions come from thermal coal mining activities, while the remainder of CMM emissions come from metallurgical coal mining.
- In Russia, approximately 60% of CMM emissions come from thermal coal mines, and the rest of CMM emissions come from metallurgical coal mining activities.
- Indonesia is responsible for 12% of the total APEC CMM emissions. Thermal coal production dominates the mining industry in Indonesia. Therefore, most of the CMM emissions come from thermal coal mining activities.
- The United States and Australia accounted for 6% and 5%, respectively. The share of CMM emissions from thermal and metallurgical coal mines is roughly equal in the Australian coal mining industry, while CMM emissions from thermal coal mining activities in the United States are slightly higher than those from metallurgical coal mines.
- Most CMM in China and Indonesia were emitted from thermal coal mines, while half of CMM emissions in Russia, the United States, and Australia were released from metallurgical coal mines in 2022.

Figure 6.7: Coal mine methane emissions in China

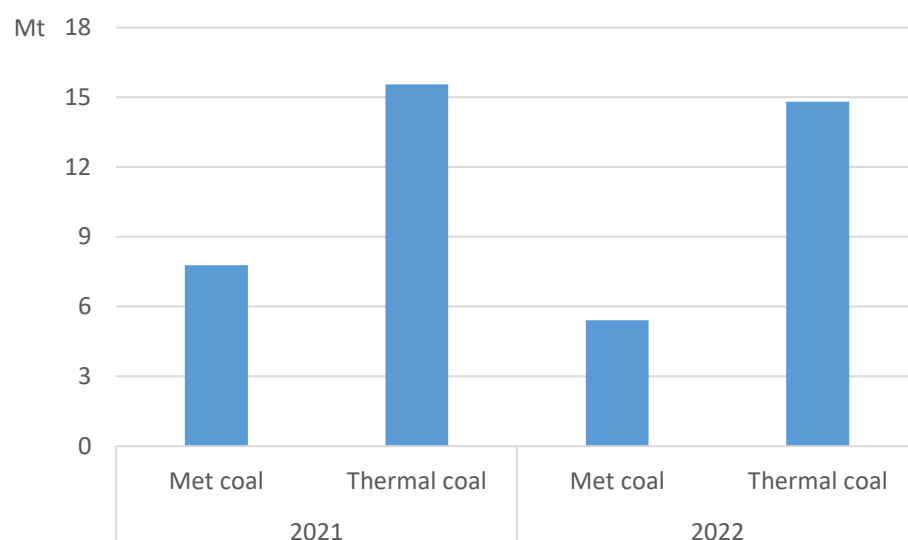

Source: compiled by the authors based on IEA (2023d).

Key points

- China produces over 14% of global methane emissions but has so far declined to join a global pact to cut its methane output by 30% by 2030, which was signed by over 150 other nations. As the largest coal producer in the world, Chinese coal mines released 20.2 Mt in 2022, 3.1 Mt lower than 2021 level.
- CMM emissions are mostly emitted from thermal coal mining activities, accounting for approximately 73% of the total CMM emissions in 2022.
- CMM emissions are often proportional to coal production in most cases. However, Chinese coal production in 2022 was 10% higher than the 2021 level, but the CMM emissions were 13.3% lower. It seems more CMM was recovered and utilised in 2022.
- According to Xinhua News, PetroChina Huabei put more than 350 coalbed methane wells into operation in the coal-rich province of Shanxi in 2022. By 2025, Shanxi aims to extract 20 -25 bcm of coalbed methane (Xinhua, 2023).
- In support of the Global Methane Initiative, the U.S. Environmental Protection Agency has completed nearly 30 full-scale and pre-feasibility studies of CMM recovery and utilization projects at Chinese coal mines. The studies assess the technical and economic viability of implementing methane recovery and utilization projects.

Figure 6.8: Coal mine methane emissions in Indonesia

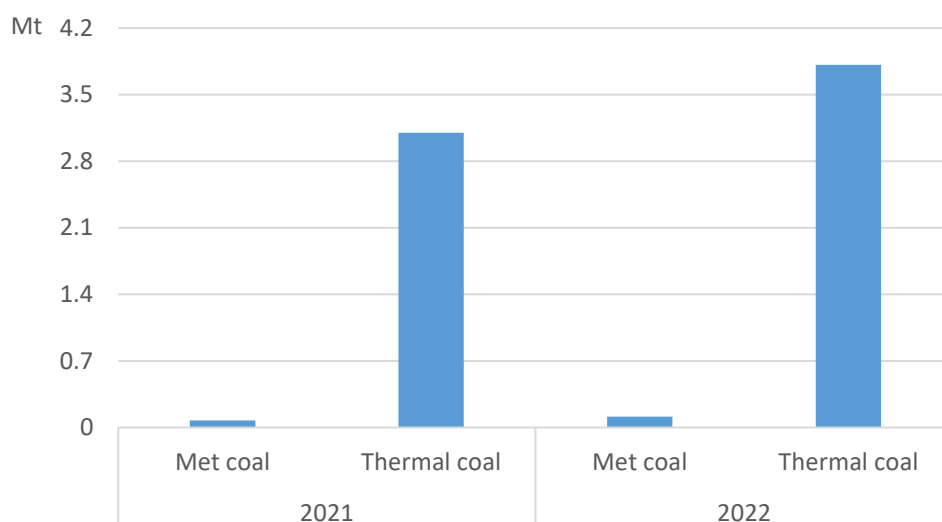

Source: compiled by the authors based on IEA (2023d).

Key points

- Indonesia joined the Global Methane Pledge at COP26 in 2021. This commitment was signed by 111 countries representing over 70% of the global economy and nearly half of all anthropogenic methane emissions.
- Indonesia's approach towards the coal mining industry will be vital in meeting its commitments as part of this pledge. This will involve investments in methane monitoring, reporting and verification (MRV), preventing mining of the most methane-intensive coal seams, and utilizing coal mine methane.
- Although there is continual coverage of methane emitted from oil and gas, coal mines emit as much methane as those fossil fuel industries. Indonesia has become a net oil importer over the past 20 years, while the country is a moderate gas exporter. The major recent trend in the Indonesian energy sector is the exponential growth of coal production and exports.
- CMM emissions are mostly emitted from thermal coal mining activities, accounting for 97% of the total CMM emissions in 2021 and 2022.
- Indonesian coal production reached approximately 14 EJ in 2022, which exceeds the level of the United States or Australia. Most of this coal production comes from surface mines rather than underground mines. However, as time passes and surface deposits are used up, the practice of underground mining is increasing.
- The depth of coal mining strongly impacts methane emissions. As a trend, the deeper the mine, the more methane is found. A tonne of coal produced from a methane-rich mine emits over ten times more of this super-pollutant than coal from an average mine.
- Even if Indonesia closes coal mines, methane can continue to leak from "abandoned" mines for many years, and this requires careful management.

Figure 6.9: Coal mine methane emissions in Australia

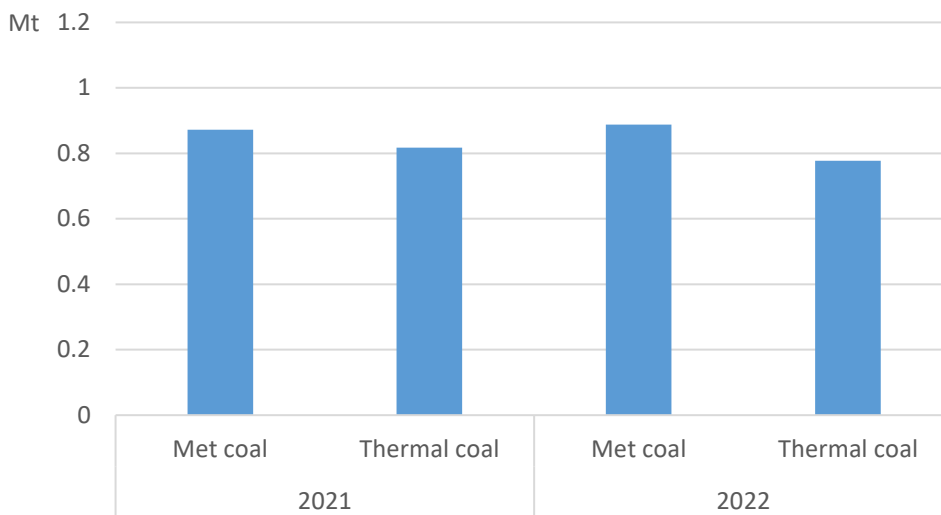

Source: compiled by the authors based on IEA (2023d).

Key points

- In 2022, CMM emissions were 1.67 Mt, including 0.89 Mt emitted from metallurgical coal and 0.78 Mt from thermal coal.
- Australia did not sign the Global Methane Pledge, and very few mechanisms to reduce coal mine methane are either required of or have been voluntarily adopted by the country's coal industry. There are readily available and effective ways to mitigate emissions of coal mine methane.
- The National Greenhouse and Energy Reporting (NGER) scheme provides the framework for monitoring and reporting greenhouse gas emissions across all sectors of the Australian economy. The NGER scheme sets out the reporting requirements and methods for emitters. Underground mines are required to measure the amount of methane produced directly, while surface mines can apply emissions factors to estimate the amount of methane produced per tonne of raw coal produced.
- Queensland hosts the highest number of operating coal mines of all Australian states and territories. These 54 mines account for over half (57.7%) of Australia's CMM emissions and represent 33% of the state's methane emissions. On average, 65% of Queensland's coal is metallurgical coal, the majority of which is produced from the state's 44 open pit mines. Queensland's coal industry reported 517 990 tonnes of methane emissions.
- CMM emissions from New South Wales coal mines account for 34% of the state's methane emissions (379 540 tonnes of methane) and contribute 42.3% of Australia's CMM emissions. When using methane's 20-year GWP, CMM emissions are equivalent to 31Mt CO₂e, responsible for an additional climate impact of 32% on top of New South Wales direct CO₂ emissions in 2019.

References

- APEC Outlook 8th, 2022. The APEC Energy Demand and Supply Outlook 8th Edition 2022, Asia Pacific Energy Research Centre. <https://aperc.or.jp/reports/outlook.php>
- Argus, 2022. <https://www.argusmedia.com/en/news/2266802-chinas-coking-coal-imports-fall-in-september>
- Barchart. <https://www.barchart.com>
- Boom and Bust Coal, 2022. Tracking the global coal plant pipeline. https://globalenergymonitor.org/wp-content/uploads/2022/04/BoomAndBustCoalPlants_2022_English.pdf
- BP, 2021. BP Statistical Review of World Energy, 70th edition. <http://www.bp.com/statisticalreview>
- BP, 2022, BP Statistical Review of World Energy, 71th edition. <http://www.bp.com/statisticalreview>
- China Macro Economy. <https://www.scmp.com/economy/economic-indicators/article/3164807/china-coking-coal-imports-down-25-cent-due-australia>
- CSIRO, 2022. Hydrogen Energy Supply Chain – Pilot Project. <https://research.csiro.au/hyresource/hydrogen-energy-supply-chain-pilot-project/>
- CSIRO, 2023. Liquefied Hydrogen Supply Chain Commercial Demonstration Project. <https://research.csiro.au/hyresource/liquefied-hydrogen-supply-chain-commercial-demonstration-project/>
- E3G, 2022. No new coal progress tracker. <https://public.tableau.com/app/profile/oyku.senlen2432/viz/NoNewCoalProgressTracker/Dashboard1>
- EGEDA, 2021. Expert Group on Energy Data Analysis, APEC Energy Working Group, APEC Energy Database. https://www.egeda.ewg.apec.org/egeda/database_info/index.html
- EGEDA, 2022. Expert Group on Energy Data Analysis, APEC Energy Working Group, APEC Energy Database. https://www.egeda.ewg.apec.org/egeda/database_info/index.html
- EIA, 2021. U.S. Energy Information Administration (EIA), <https://www.eia.gov/international/overview/world>
- Energy Institute, 2023. Statistical Review of World Energy, <https://www.energyinst.org/statistical-review/resources-and-data-downloads>
- ERIA, 2023. Study on the Applicability of CCT for a Comprehensive and Optimal Carbon-neutral Solution in ASEAN.
- G7 Germany. <https://www.g7germany.de/g7-en/current-information/g7-summit-outcomes-2058314>
- Global CCS Institute, 2020. https://www.globalccsinstitute.com/wp-content/uploads/2020/12/Global-Status-of-CCS-Report-2020_FINAL_December11.pdf
- Global CCS Institute, 2023. The Global Status of CCS Report 2023.
- Global Energy Monitor, <https://globalenergymonitor.org/projects/global-coal-public-finance-tracker/tracker-map/>

Geoscience Australia. <https://www.ga.gov.au/data-pubs/data-and-publications-search/publications/australian-minerals-resource-assessment/coal>

HySTRA, CO₂-free Hydrogen Energy Supply-chain Technology Research Association. <https://www.hystra.or.jp/en/about/> . <https://www.hystra.or.jp/en/about/>

ICSC, 2022. The role of low emission on coal technologies in a net zero Asian future. International Centre for Sustainable Carbon.

IEA, 2019b. The Future of Hydrogen – Seizing today’s opportunities.

IEA, 2020b. Coal 2020, analysis and forecast to 2025. <https://www.iea.org/reports/coal-2020>

IEA, 2021. 2021 IEA World energy balances and statistics, World energy balances and statistics – Data services.

IEA, 2022. Global Methane Tracker 2022. <https://www.iea.org/reports/global-methane-tracker-2022#> Global Methane Tracker 2023.

IEA, 2023. World Energy Statistics, August 2023 updates.

IEA, 2023a. Coal Market Update 2023. <https://www.iea.org/reports/coal-market-update-july-2023/demand>

IEA, 2023b. World Energy Balances, August 2023 updates.

IEA, 2023c. Strategies for Coal Transition in Korea. <https://iea.blob.core.windows.net/assets/a57dae0b-4b80-429b-bf37-eaa33041c4b7/StrategiesforCoalTransitioninKorea.pdf>

IEA, 2023d. Global Methane Tracker 2023. <https://www.iea.org/reports/global-methane-tracker-2023/strategies-to-reduce-emissions-from-coal-supply>

International CCS Knowledge Centre. <https://ccsknowledge.com/>

Japan Beyond Coal, <https://beyond-coal.jp/en/the-problem/info03/>

JERA, 2022. JERA and IHI Move Up the Start of Large-Volume Co-firing of Fuel Ammonia in the Demonstration Project at Hekinan Thermal Power Station. https://www.jera.co.jp/en/news/information/20220531_917

Joban Power. <http://www.joban-power.co.jp/igcc-en/unit10-en/features-en/>

Kiko Network, <https://www.kiconet.org/press-release-en/2022-06-29/g7summit2022>

Korppoo, A. et al., 2021. The Russian Coal Sector in a Low-Carbon World: Prospects for a Coal Transition? Insights Report, Climate Strategies.

METI Journal, https://www.meti.go.jp/english/publications/pdf/journal2013_10a.pdf

METI, 2020, Green Growth Strategy Through Achieving Carbon Neutrality in 2050, https://www.meti.go.jp/english/policy/energy_environment/global_warming/ggs2050/index.html

METI, 2020. Green Growth Strategy Through Achieving Carbon Neutrality in 2050, https://www.meti.go.jp/english/policy/energy_environment/global_warming/ggs2050/index.html

MHI. Mitsubishi Heavy Industries. <https://www.mhi.co.jp/technology/review/pdf/e563/e563030.pdf>

MHI, 2023. Mitsubishi Heavy Industries, MHI Signs MoU to Collaborate in Feasibility Studies on Ammonia Co-Firing for Power Generation in BLCP Power Station. <https://www.mhi.com/news/230116.html>

Mongabay, 2023. <https://news.mongabay.com/2023/07/indonesias-coal-burning-hits-record-high-and-green-nickel-is-largely-why/>

Mongabay, 2022. <https://news.mongabay.com/2022/08/biomass-cofiring-loopholes-put-coal-on-open-ended-life-support-in-asia/>

NextBig Future, <https://www.nextbigfuture.com/2017/03/japan-india-and-china-still-turning-to.html>

Net Zero Tracker, <https://zerotracker.net/>

Nikkei Asia, <https://asia.nikkei.com/Spotlight/Environment/Climate-Change/Japan-halts-aid-for-coal-fired-plants-in-Indonesia-Bangladesh>

Osaki CoolGen Corporation. <https://www.osaki-coolgen.jp/en/project/step3.html>

Our World in Data. <https://ourworldindata.org/emissions-by-fuel> <https://ourworldindata.org/emissions-by-fuel>

PDP8, 2023. National Power Development Plan (PDP8) for 2021 - 2030, with a vision to 2050.

Power, 2021. <https://www.powermag.com/japan-ushers-in-new-era-for-igcc-coal-power/>

Power, 2022. A Japanese Project Demonstrates a Carbon Neutrality Pathway for Coal Power. <https://www.powermag.com/a-japanese-project-demonstrates-a-carbon-neutrality-pathway-for-coal-power/>

Power, 2023. China's Pingshan Phase II Sets New Bar as World's Most Efficient Coal Power Plant. <https://www.powermag.com/chinas-pingshan-phase-ii-sets-new-bar-as-worlds-most-efficient-coal-power-plant/>

SaskPower. <https://www.saskpower.com/about-us/our-company/blog/2021/bd3-status-update-july-2021>

S&P Global, 2021, <https://www.spglobal.com/platts/en/market-insights/latest-news/metals/071421-trade-review-no-peak-in-sight-for-met-coal-prices-as-supply-continues-to-tighten>

S&P Global, 2023. China's hunger for coal sparks debate on self-sufficiency and imports. <https://www.spglobal.com/en/>

The New York Times. China Is Burning More Coal, a Growing Climate Challenge. <https://www.nytimes.com/2022/11/03/business/energy-environment/china-coal-natural-gas.html>

Trading Economics. <https://tradingeconomics.com/commodity/coal>

Xinhua, 2023. <https://english.news.cn/20230320/8be5236035ed4e44a0479f9fc87ddcd1/c.html#:~:text=Shanxi%20is%20one%20of%20the%20third%20of%20the%20country%27s%20total>

Xing Zhang and Simone Meloni, 2020. Technology developments in the cofiring of biomass, IEA Clean Coal Centre.

World Resources Institute, 2023. These 10 Countries Are Phasing Out Coal the Fastest. <https://www.wri.org/insights/countries-phasing-out-coal-power-fastest>