

Costs and benefits of large-scale deployment of wind turbines and solar PV in Mongolia for international power exports



Takashi Otsuki

Asia Pacific Energy Research Centre (APEREC), The Institute of Energy Economics, Japan (IEEJ), Inui Bldg.-Kachidoki 11F, 1-13-1 Kachidoki, Chuo-ku, Tokyo 104-0054 Japan

ARTICLE INFO

Article history:

Received 5 October 2016
Received in revised form
28 December 2016
Accepted 7 February 2017
Available online 13 February 2017

Keywords:

Grid interconnections
Electricity trade
Renewable energy
Northeast Asia Super Grid
Linear programming
Energy systems modeling

ABSTRACT

Power grid interconnection has gained attention in Northeast Asia (NEA) as a means to effectively utilize the abundant renewable resources in Mongolia. This paper quantifies the potential economic and environmental benefits of deploying massive wind turbines and solar PV in Mongolia for power exports. The author uses an NEA-wide multi-region power system model formulated as a linear programming problem. The analysis considers power systems characteristics, such as the seasonal and daily electric load curves of the NEA regions.

The simulation results show that the large-scale Mongolian renewables contribute to significant CO₂ reductions in NEA. China, in particular, benefits from a significant reduction in coal-fired generation. However, huge investments would be required for the massive renewables and cross-boundary transmission facilities, pushing up electricity supply cost. The relevant planning organizations need to carefully consider these environmental opportunities and economic barriers before implementation. This paper also investigates the economic impacts of transmission route circuitry due to avoiding transmission through the Democratic People's Republic of Korea (DPRK). Our results imply modest effects of the circuitry on the total system cost; availability of routes through the DPRK would not significantly increase the benefits to the NEA system of integrating massive renewables in Mongolia.

© 2017 The Author(s). Published by Elsevier Ltd. This is an open access article under the CC BY license (<http://creativecommons.org/licenses/by/4.0/>).

1. Introduction

International power grid interconnection becomes potentially attractive to decarbonize the electricity sector in Northeast Asia¹ (NEA), especially after several recent regional events, including the Fukushima nuclear disaster in Japan, the power shortage in Korea, and increased concern about air pollution in China. These three major electricity consuming countries, together accounting for 31% of world electricity demand in 2013 [1], have recently reaffirmed the importance of lower-carbon and more resilient energy systems. Their governments and/or industries are currently discussing alternative energy supply options, including imports from foreign countries [2–4]. At the same time, other neighboring NEA countries with abundant renewable resources, in particular, Mongolia, have shown strong interest in developing renewables

and exporting electricity to attract new investment [5]. According to Elliott et al. [6] and Energy Charter et al. [7], estimated wind and solar photovoltaics (PV) potential in Mongolia reach 1100 GW² and 1500 GW, respectively. Thus, several multilateral interconnection schemes have been proposed in NEA, with a focus on renewable energy developments in Mongolia for international power exports [7]. Also, relevant organizations, including GEIDCO initiated by State Grid Corporation of China, have started discussion and planning from various perspectives, such as economic, environmental, legal and institutional [3,4,8].

This research aims to examine the economic viability of developing the abundant wind and solar resources in Mongolia for international power exports. There have previously been various studies examining renewable energy integration and transmission expansion in each individual country in NEA³; however, few papers so far have quantified the costs and benefits of the Mongolian

E-mail address: takashi.otsuki@aperc.ieej.or.jp.

¹ This paper defines Northeast Asia as the following six countries: China, the Democratic People's Republic of Korea (DPRK), Japan, the Republic of Korea (Korea), Mongolia and Russia.

² Good-to-Excellent wind resource estimated in Elliott et al. [6].

³ For example, see Refs. [47] and [48] for China [28], and [49] for Japan [50], and [51] for Korea and [52] for Russia.

renewables for power trade. There are several studies which have performed modeling and analyses of international power trade in NEA [7,9–13]. Yet, these studies, except for Energy Charter et al. [7] and Otsuki et al. [13], did not consider wind and solar resources in Mongolia. As for Energy Charter et al. [7] and Otsuki et al. [13], the scenarios discussed in their analyses limited the Mongolian renewables to 100 GW (50 GW wind and 50 GW solar PV), despite the huge estimated potential.

This study utilizes an NEA-wide multi regional power system model, formulated as a linear programming problem. This model considers power system characteristics, including seasonal and daily electric load curves of each region and output profiles of renewables in Mongolia. Compared with the author's previous study [13], the novelty of this paper includes the two points as follows:

- Quantification of the costs and benefits of large-scale (such as 2000 GW-scale) deployments of Mongolian renewables for international exports, and
- Expansion of the modeled grids in China, from two in our previous study (CH-N and CH-NE) to the all markets in this paper (Fig. 2). This enhancement allows us to consider China's large market and to discuss the optimal grid integration of massive Mongolian renewables in a more comprehensive and convincing manner.

Although uncertainties exist regarding the degree of future energy cooperation that can be achieved in NEA, the author believes that this paper can contribute to stakeholders' and policy makers' discussions by quantitatively providing findings and implications from an economic perspective.

This paper proceeds as follows: Section 2 gives an overview of the multi-region power system model; Section 3 presents the simulation results; and Section 4 summarizes major conclusions and implications, and then proposes a future research agenda.

2. Methods

2.1. Overview of the multi-region power system model

This paper uses a multi-region power system model developed by Otsuki et al. [13].⁴ This is a linear programming model, which aims to minimize a single-year total system cost, consisting of the annualized initial cost, operation and maintenance (O&M) cost, fuel cost and carbon cost for the whole of NEA under various technical and political constraints. Hence the NEA economies are assumed to cooperate fully to achieve the regional optimization. Although the degree of future energy cooperation in NEA is uncertain, this paper assumes the most ideal situation in order to quantify the maximum benefits potentially obtainable from developing renewables in Mongolia for power exports. Fig. 1 is a schematic diagram of this model. An additional enhancement to the model used in this study compared to our previous work is the inclusion of battery storage technology. Detailed mathematical descriptions and model validation are provided in Otsuki et al. [13]. The assumed discount rate to annualize initial investments is 5%; carbon cost considers only direct emissions from fuel combustion.

Fig. 2 illustrates the modeled nodes, and lines between nodes indicate the assumed transmission routes. Two transmission routes through the DPRK (dotted lines in Fig. 2) are not considered in Sections 3.1–3.5.1; instead, we perform a sensitivity analysis with these routes included in Section 3.5.2 as the routes through the

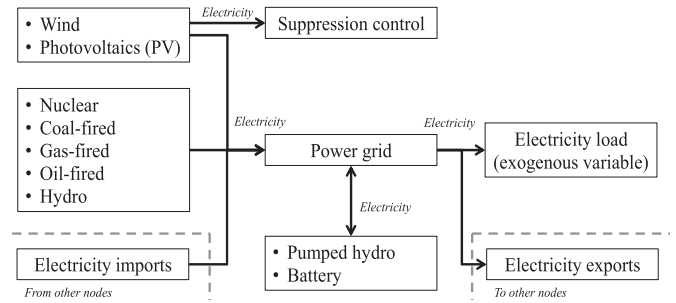

Fig. 1. Schematic diagram of the multi-region power system model.

DPRK stand out for presenting significant diplomatic challenges. Regarding temporal resolution, this study selected the same temporal resolution as our previous study [13], which considers the hourly load curves of typical days for five seasons (summer-peak, summer-average, winter-peak, winter-average, and intermediate).

2.2. Case settings

The author simulated a total of twenty one cases: a Base case and twenty Mongolian renewables cases (*Mon100 GW*, *Mon200 GW*, ..., *Mon2000 GW*) as shown in Table 1. The simulated year in this study is 2030. The *Base* case assumes no grid expansion from the initial transmission capacity assumptions. The *Mon100 GW*–*Mon2000 GW* cases attempt to quantify the costs and benefits of large-scale deployment of the Mongolian renewables. Each of these cases adds 100 GW of Mongolian renewable generation capacity to the previous one, split equally between wind and solar PV. For example, the *Mon100 GW* case assumes 50 GW of wind turbines and 50 GW of solar PV; the *Mon200 GW* case assumes 100 GW of wind turbines and 100 GW of solar PV, and so on; the *Mon2000 GW* case assumes 1000 GW of wind turbines and 1000 GW of solar PV. As this paper employs an optimization model, the results in Section 3 present a “best-case” outcome under each level of Mongolian renewable capacity.

Transmission line capacity and transmitted power are cost optimized in the *Mon100 GW*–*Mon2000 GW* cases. Otsuki et al. [13] limited the net transmission inflows at each of the city nodes to reflect likely concern about transmission interruptions (Equation (A.26) in Ref. [13]); since this study is seeking to quantify the maximum benefits potentially obtainable from developing renewables in Mongolia, there is no such constraint here. The model also determines fossil fuel-fired capacity and generation. However, for coal-fired capacity, we impose upper bounds based on the business-as-usual scenario in APERC [14], reflecting each country's environmental concerns about expanding coal-fired plants. The assumed carbon price for all cases is 30 USD/tCO₂. Further explanations of the assumptions are given in Section 2.3.

In the *Mon2000 GW* case, 1000 GW of wind turbines and 1000 GW of solar PV are about 90% of Mongolia's estimated wind potential and about two-thirds of Mongolia's estimated solar PV potential. The land area required would be approximately 0.16 million km², which is equivalent to 10% of the land area of Mongolia. Assumptions for this estimate are as follows: the land area of Mongolia is 1.56 million km²; the land area required for wind turbines and solar PV cells are about 140 km²/GW [6] and 20 km²/GW [15], respectively. This vast land use would bring some significant social, economic and environmental impacts in Mongolia, including changes in land-use, industrial structure and traditional nomadic lifestyles. Comprehensive examination of these socio-economic and environmental impacts would be needed in future studies.

⁴ For its modeling work, Otsuki, et al. [13] refers to the detailed approach in Komiyama et al. [28], Schaber, et al. [36] and Steinke et al. [46].

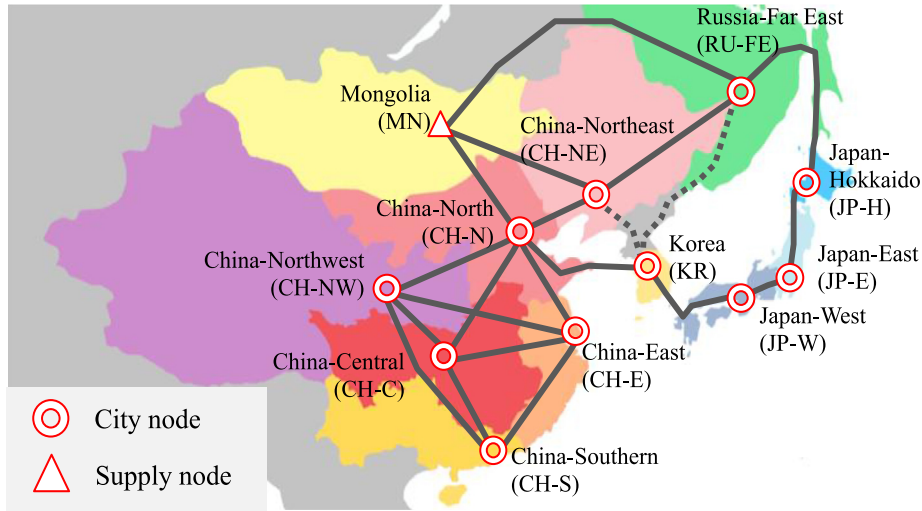

Fig. 2. Regional division and assumed transmission routes. Note: The two transmission routes through the DPRK (dotted lines) are considered in Section 3.5.2. City nodes have electricity demand as well as generation and storage facilities, while the supply node has only generation and/or storage facilities to export to neighboring nodes.

Table 1
Case settings.

	Base case	Mongolian Renewables Cases (<i>Mon100 GW case, Mon200 GW case, ..., Mon2000 GW case</i>)
Wind and PV capacity at Mongolia (MN) node	Not considered.	50 GW each for the <i>Mon100 GW case</i> , 100 GW each for the <i>Mon200 GW case</i> , ..., 1000 GW each for the <i>Mon2000 GW case</i> .
Cross-boundary transmission capacity	No new additions	Economically optimized with no limit on capacity additions. For the supply node (MN), total transmission capacity is assumed to match the renewable capacity there (explained as constraint (A.28) in Ref. [13]).
Other capacity		City nodes: Fossil fuel-fired and battery capacity are economically optimized, with limits for coal-fired capacity based on the projected capacity for 2030 from APERC [14]. Renewables and pumped storage capacity is given based on the projection in APERC [14]. MN: Battery installation is allowed. Other technologies are not included.
Carbon price		30 USD/tCO ₂ for all cases.

2.3. Input data assumptions

2.3.1. Electricity demand and load curves

We estimated electricity demand from the projections in APERC [14]. As APERC [14] shows each of these demands on a country-wide basis, we disaggregated them into nodal demand by referring to historic data for each node [16]. Daily load curves for the five seasons (Fig. 3) in the modeled China nodes are from JEPIC [17], and those in the other nodes are estimated in Otsuki et al. [13].

2.3.2. Generation and storage facilities

Fig. 4 depicts initial capacity settings for the generation and storage facilities. The model is allowed to endogenously add fossil fuel-fired generation and battery capacity at the city nodes. At the supply node (MN), power generation capacity is given exogenously for all cases as shown in Table 1.

The initial capacity of fossil fuel-fired plants is based on existing capacity [18–21]. For coal-fired plants, we impose the upper bounds as mentioned in Section 2.2. Capacities for renewables (except for Mongolia), nuclear and pumped hydro are given

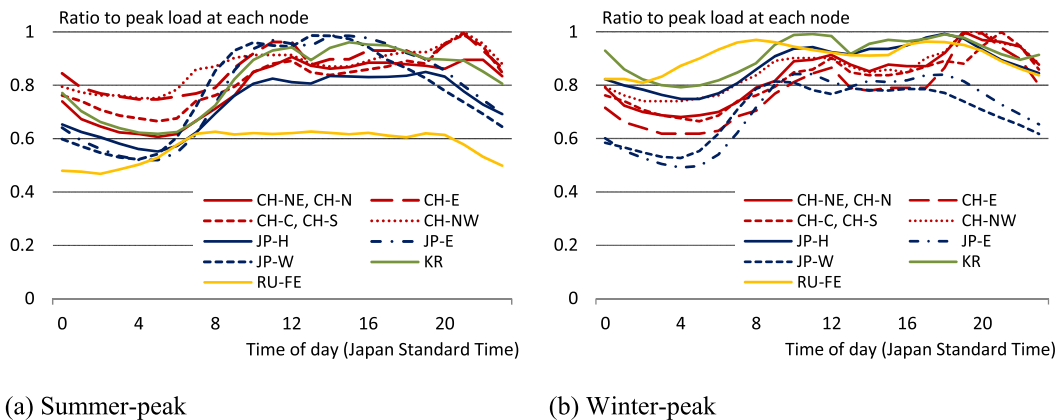

Fig. 3. Assumed electric load curves at city nodes in the summer-peak and winter-peak seasons (ratio to peak load at each node).

Table 3

Cost assumptions for the China nodes (CH-NE, CH-N, CH-E, CH-C, CH-NW, and CH-S).

	Nuclear	Coal	Gas	Oil	Hydro	Wind	PV	Pumped hydro	Battery
Initial cost [USD/kW]	2600	750	700	800	2500	1300	1500	2500	1440
Fuel cost [USD/kWh]	0.014	0.019	0.040	0.088	0	0	0	0	0
Fixed O&M cost [USD/kW/yr]	68	15	14	16	30	33	23	30	14
Variable O&M cost [USD/kWh]	0.001	0.002	0.003	0.003	0	0	0	0	0.04
Maximum availability [%]	80	70	90	90	40	20	Estimated profile	85	85
Carbon content of fuel [gCO ₂ /kWh]	0	329	200	249	0	0	0	0	0
Efficiency [%]	100	38	53	41	–	–	–	–	–

Table 4

Cost assumptions for the Japan nodes (JP-H, JP-E, and JP-W).

	Nuclear	Coal	Gas	Oil	Hydro	Wind	PV	Pumped hydro	Battery
Initial cost [USD/kW]	4000	2400	1150	1900	6000	1700	2500	6000	1440
Fuel cost [USD/kWh]	0.014	0.021	0.056	0.088	0	0	0	0	0
Fixed O&M cost [USD/kW/yr]	104	48	23	39	72	43	38	72	14
Variable O&M cost [USD/kWh]	0.002	0.005	0.006	0.004	0	0	0	0	0.04
Maximum availability [%]	70	75	70	90	40	20	Estimated profile	85	85
Carbon content of fuel [gCO ₂ /kWh]	0	339	205	257	0	0	0	0	0
Efficiency [%]	100	42	51	41	–	–	–	–	–

Table 5

Cost assumptions for the Korea node (KR).

	Nuclear	Coal	Gas	Oil	Hydro	Wind	PV	Pumped hydro	Battery
Initial cost [USD/kW]	3300	1500	800	1900	2500	1600	2250	2500	1440
Fuel cost [USD/kWh]	0.014	0.021	0.056	0.088	0	0	0	0	0
Fixed O&M cost [USD/kW/yr]	86	30	16	39	30	40	34	30	14
Variable O&M cost [USD/kWh]	0.002	0.003	0.004	0.004	0	0	0	0	0.04
Maximum availability [%]	95	90	90	90	40	20	Estimated profile	85	85
Carbon content of fuel [gCO ₂ /kWh]	0	328	202	249	0	0	0	0	0
Efficiency [%]	100	38	53	41	–	–	–	–	–

Table 6

Cost assumptions for the Russia Far East node (RU-FE).

	Nuclear	Coal	Gas	Oil	Hydro	Wind	PV	Pumped hydro	Battery
Initial cost [USD/kW]	2800	2200	1000	1200	2500	1500	2000	2500	1440
Fuel cost [USD/kWh]	0.014	0.018	0.040	0.088	0	0	0	0	0
Fixed O&M cost [USD/kW/yr]	73	44	20	24	30	38	30	30	14
Variable O&M cost [USD/kWh]	0.001	0.005	0.005	0.003	0	0	0	0	0.04
Maximum availability [%]	80	70	90	90	40	20	Estimated profile	85	85
Carbon content of fuel [gCO ₂ /kWh]	0	287	198	220	0	0	0	0	0
Efficiency [%]	100	31	36	41	–	–	–	–	–

Table 7

Cost assumptions for the Mongolia node (MN).

	Wind	PV	Battery
Initial cost [USD/kW]	1300	1500	1440
Fixed O&M cost [USD/kW/yr]	33	28	14
Variable O&M cost [USD/kWh]	0	0	0.04
Maximum availability [%]	Estimated profile		85

Note: This table shows only the technologies considered in MN in this study.

impact on the whole NEA system. The share of fossil fuel-fired generation does decline in this case, but only by two percentage-points due to the large market size of NEA countries, especially China.⁵ Hence, further deployments—much more than the proposal in the *Gobitec* concept—need to be considered by the relevant planning organizations to reap large environmental benefits.

Balancing electricity supply and demand becomes more of a challenge as variable renewable generation capacity grows. Generated electricity that exceeds either customer demand or the ability of the system to transmit would be dealt with various measures, including electricity storage or suppression. Suppression control (also called “curtailment”) is a reduction in the output of power from what the generator would otherwise produce given the available resource [43]. In this study, the cost-optimization model selects suppression control if it is more economic compared to the costs for additional storage or additional transmission facilities to utilize the excess generation.

Demand for electricity storage and suppression control is modest up to the *Mon500 GW* case. The NEA power system integrates the Mongolian renewables mainly by flexible operation of fossil fuel-fired plants in these cases, resulting in smaller coal-fired generation (Fig. 5a). Fig. 6 shows an example of power generation profiles in China-North (CH-N) and MN. In the *Mon500 GW* case, CH-N integrates the renewable power from MN by the ramping up/down of coal and gas-fired plants during the daytime.

⁵ See also modest emissions reductions described in Fig. 10.

Table 8
Initial cost assumptions for each interconnection route [USD/kW].

	CH-NE	CH-N	CH-E	CH-C	CH-NW	CH-S	JP-H	JP-E	JP-W	KR	RU-FE	MN
CH-NE	—	1644	—	—	—	—	—	—	—	(1533)	2549	2466
CH-N	1644	—	2354	3023	2521	—	—	—	—	2805	—	1853
CH-E	—	2354	—	3023	3440	2605	—	—	—	—	—	—
CH-C	—	3023	3023	—	1853	2438	—	—	—	—	—	—
CH-NW	—	2521	3440	1853	—	3774	—	—	—	—	—	—
CH-S	—	—	2605	2438	3774	—	—	—	—	—	—	—
JP-H	—	—	—	—	—	—	—	2084	—	—	4093	—
JP-E	—	—	—	—	—	—	2084	—	1268	—	—	—
JP-W	—	—	—	—	—	—	—	1268	—	2513	—	—
KR	(1533)	2805	—	—	—	—	—	—	2513	—	(2967)	—
RU-FE	2549	—	—	—	—	—	4093	—	—	—	—	—
MN	2466	1853	—	—	—	—	—	—	—	—	—	—

Note: “—” indicates that interconnections are not allowed in this study. See Fig. 2 for the node abbreviations. Initial costs for the two transmission routes through the DPRK (see the note in Fig. 2) are shown with brackets.

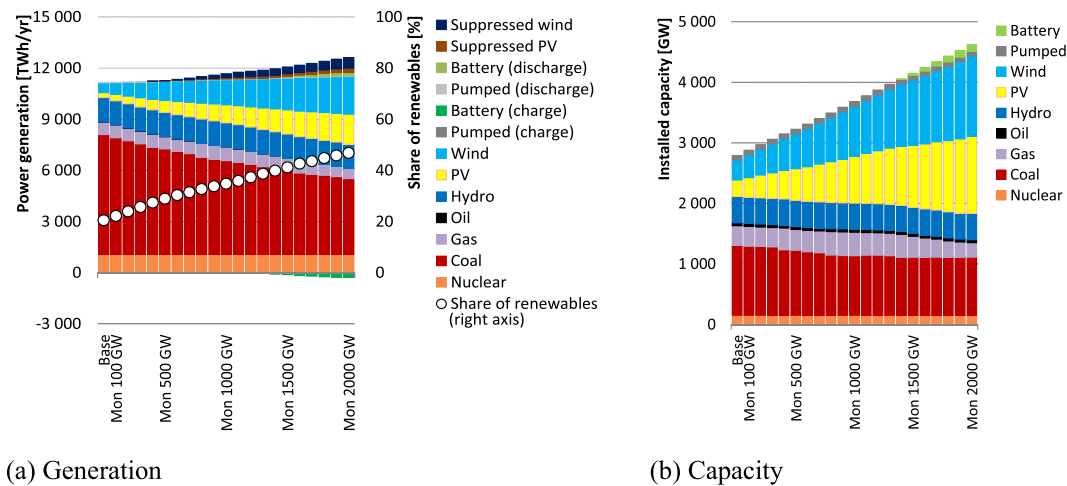

Fig. 5. Power generation and installed capacity in Northeast Asia.

Beyond the *Mon500 GW* case, various integration measures, not only flexible operation of fossil fuel-fired generation, but also suppression control and electricity storage, are dynamically combined to accommodate renewable power from Mongolia (Figs. 5 and 6). Suppressed wind and PV amounts to 325 TWh/yr in the *Mon1000 GW* case and reaches 850 TWh/yr in the *Mon2000 GW* case, which respectively means that 16% and 21% of renewables generation in MN is discarded from the grid. Fig. 6b implies that suppression control would play an important role in balancing supply and demand especially during the daytime in order to manage the PV surges in MN (see the *Mon1000 GW* and *Mon2000 GW* cases).

Battery capacity grows from the *Mon1400 GW* case, and reaches about 110 GW (mainly in CH-N) in the last case. Similarly to suppression control, battery storage in CH-N is utilized to absorb the surplus electricity during the daytime, when solar PV surges in MN, and discharge during the night to supply the peak load (See the last case in Fig. 6a). However, the model selects suppression control, rather than larger-scale battery storage or transmission to other nodes, as mentioned in the previous paragraph. The main reasons for this are the high costs of battery storage and transmission lines. We confirmed this point by conducting a sensitivity analysis on the costs (see Appendix).

Fig. 7 describes the power generation mix and net imports' share by node in the selected cases. Power trade is limited in the *Base* case; the net imports' share is not more than 1% in all nodes except for China-East (CH-E). The imports of CH-E are mainly from

China-Central (CH-C), where abundant hydro resources are available to meet the demand in the coastal electricity-consuming area. With the massive Mongolian renewables, China-North (CH-N) and Korea (KR) become the two major nodes that increase their share of net imports. This share grows to 29% (630 TWh/yr) in CH-N and 19% (130 TWh/yr) in KR in the *Mon500 GW* case and it grows to 75% (1,612 TWh/yr) in CH-N and 54% (358 TWh/yr) in KR in the *Mon2000 GW* case. The large-scale Mongolian renewables contribute to a massive reduction in fossil fuel generation, especially in these two countries. In China, coal-fired generation drops by 36%, from 6,370 TWh/yr in the *Base* case to 4,100 TWh/yr in the *Mon2000 GW* case, leading to significant CO₂ emission reductions (Section 3.2). Reduced coal-fired generation would also be desirable in China to relieve air pollution. The imported power in KR significantly replaces both gas-fired and coal-fired generation.

Other nodes, such as CH-NE, JP-W and RU-FE, also increase imports 21–44% as shown in Fig. 7c–d. In contrast, the net imports of JP-E are modest, only about 5%, even with 2000 GW of renewables in MN. The modest imports in JP-E are slightly different from what was reported in our previous study.⁶ One of the reasons is the higher transmission costs assumed in this study (See Section 2.3.3 and Appendix). Interconnection costs need to be lower for JP-E to actively participate in the international electricity trade in NEA.

⁶ In Otsuki et al. [13], the net imports' share in JP-E reaches almost 10% with 100 GW of Mongolian renewables.

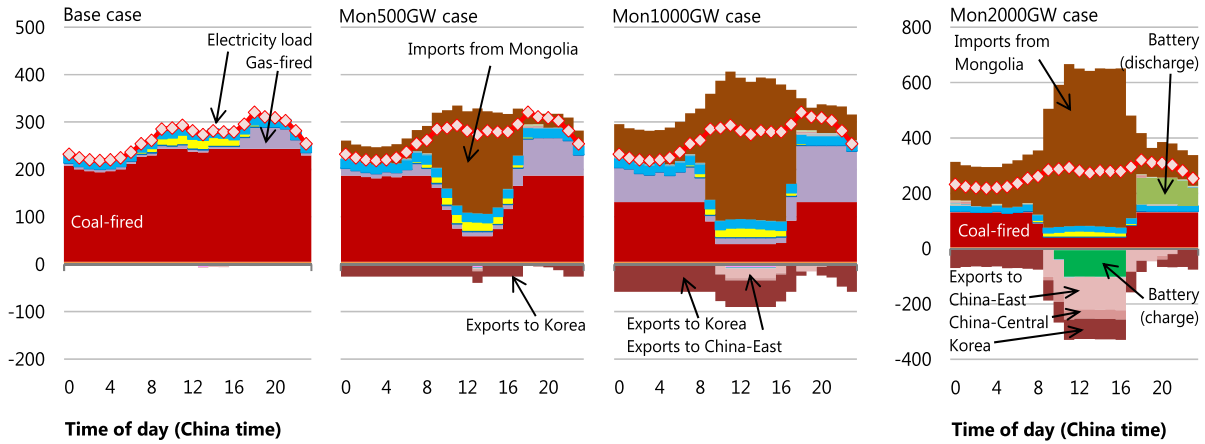

(a) The China-North (CH-N) node

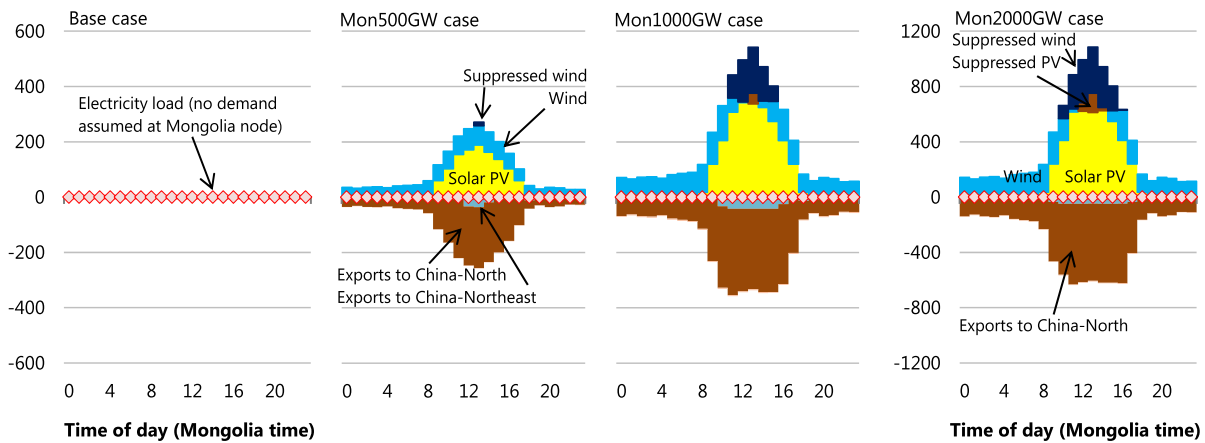

(b) Mongolia (MN) node

Fig. 6. Power generation profile in the winter-peak season in CH-N and MN in the selected cases.

3.2. CO₂ emissions

Fig. 8 displays annual CO₂ emissions from fossil fuel combustion. The Mongolian renewables contribute to significant emissions reductions in NEA. Total NEA power generation emissions decrease by 10% (679 MtCO₂) with 400 GW of Mongolian renewables, 30% (2,127 MtCO₂) with 1600 GW and 36% (2,473 MtCO₂) with 2000 GW. Our results imply a potential global-scale benefit from the Mongolian renewables. According to IEA's current policy scenario [30], global energy-related emissions in 2030 are projected to be 39,153 MtCO₂, and electricity sector emissions to be 17,114 MtCO₂; therefore, the absolute reductions in the last case would be about 6% of total global emissions and more than 14% of electricity sector emissions.⁷ Renewable resources in Mongolia therefore have a large potential role to play in mitigating climate change.

Among the modeled nodes, China and Korea are most

significantly benefited from an environmental perspective, which can be a strong incentive for these countries to import Mongolian renewables. China shows the largest CO₂ emission reductions in absolute terms, for example, by 2,095 MtCO₂ (–35%) in the *Mon2000 GW* case, as the Mongolian renewables significantly replace carbon-intensive coal-fired generation in CH-N and CH-NE (Fig. 7d). Korea's CO₂ reductions reach about 90% in the *Mon2000 GW* case because imported power largely replaces both gas and coal-fired generation. In contrast, the results show relatively small effects for Japan, with only 13% reductions even in the *Mon2000 GW* case, yet the environmental benefits in the country as a whole become modest due to limited electricity imports in other Japan nodes (JP-H and JP-E).

3.3. Cross-boundary electricity transmission

Fig. 9 illustrates the cross-boundary electricity transmission [TWh/yr] and transmission capacity [GW]. The massive Mongolian renewables stimulate increased cross-boundary electricity transmission. The *Base case* shows relatively modest electricity transmission except between CH-C and CH-E, and the power trade grows

⁷ CO₂ emissions calculated in this paper are approximately in line with IEA's current policy scenario [30]. For example, emissions in 2030 in China are 6,028 MtCO₂ in the *Base case* and 6,036 MtCO₂ in IEA [30], and are 457 MtCO₂ and 440 MtCO₂ in Japan, respectively. As for Korea and Russia Far East, the author could not confirm as neither one is not shown in IEA [30].

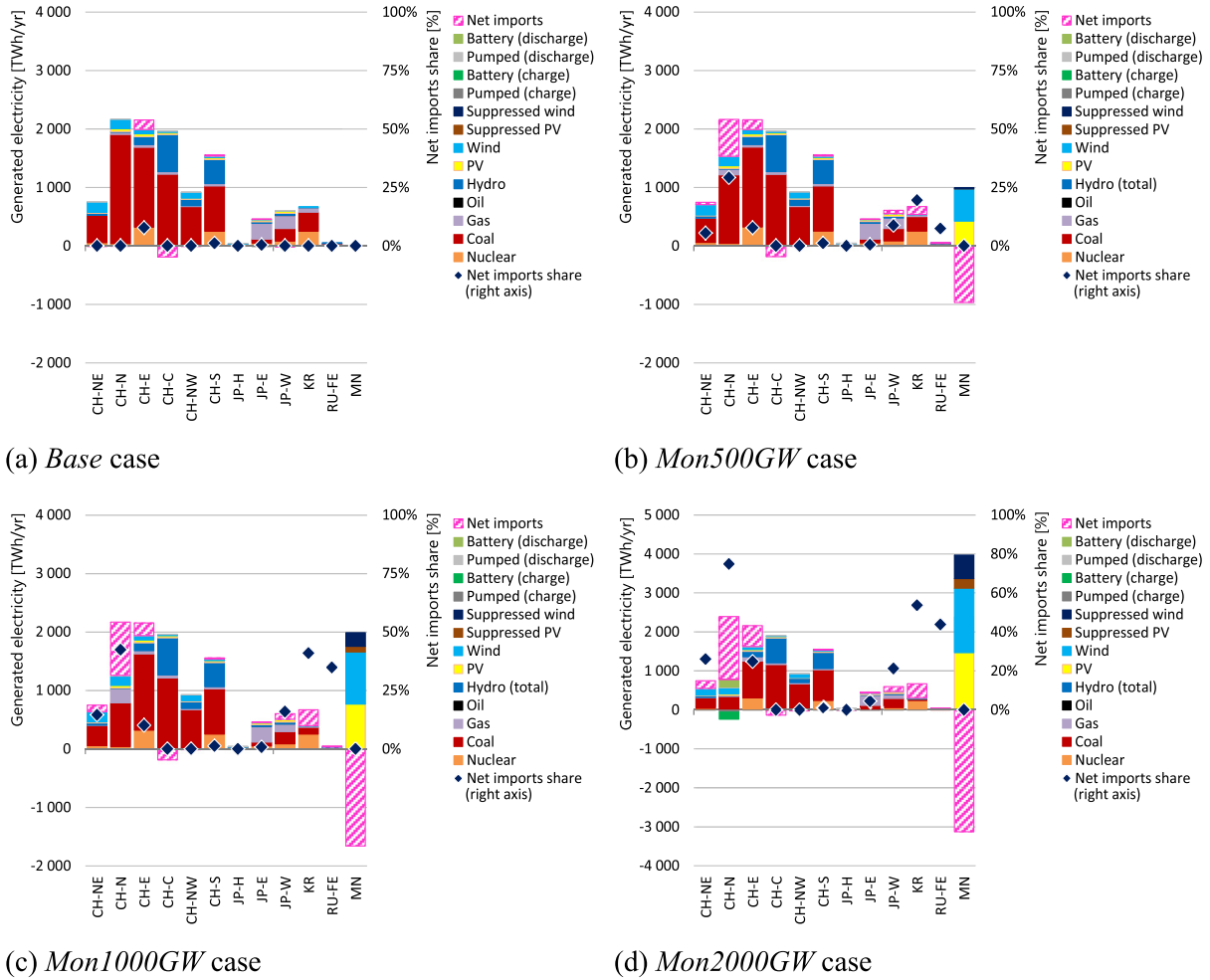

Fig. 7. Power generation mix and net imports by node in selected cases.

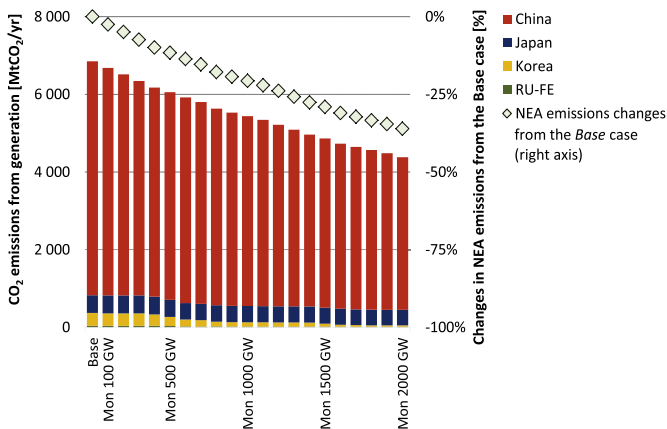

Fig. 8. Annual CO₂ emissions from power generation in the modeled city nodes, Northeast Asia.

with the deployment of the renewables in MN, especially in the route from Mongolia (MN) to China-North (CH-N), Korea (KR) and Japan-West (JP-W) and from MN to CH-N and China-East (CH-E). Vast amounts of electricity are estimated to flow into the major importing nodes, such as CH-N and KR. In the *Mon2000 GW* case, transmission from MN to CH-N reach 2,667 TWh/yr, which exceeds

the assumed annual demand in CH-N (2,155 TWh/yr). As for KR, the estimated inflow from CH-N is 519 TWh/yr, equivalent to three-quarters of KR's annual demand. As for the transmission lines from MN, the variability of the renewable generation results in relatively low utilization rates of the lines; for example, 16% on the MN-CH-N connection in the *Mon2000 GW* case.

3.4. Costs

Fig. 10 depicts yearly total system cost in NEA. The costs shown include a carbon cost of 30 USD/tCO₂ for all cases. The annual initial costs are estimated by multiplying total investments by a capital recovery factor assuming a discount rate of 5%.

Massive deployments of Mongolian renewables and cross-boundary transmission lines significantly change the cost structure to be more capital intensive, pushing up the annual system cost (Fig. 10). In the *Base Case*, the largest cost component is fuel costs, which are about half of total system cost, while initial costs become the largest cost component in the *Mon2000 GW* case, accounting for 55% of total system cost. The Mongolian renewables contribute to savings in fuel and carbon costs. However, the incremental capital and O&M costs are estimated to be larger than the savings, resulting in a higher annual system cost by about 30%–1,391 Billion USD/yr (B USD/yr) in the *Mon2000 GW* case compared to 1,053 B USD/yr in the *Base case*. These annual system costs are

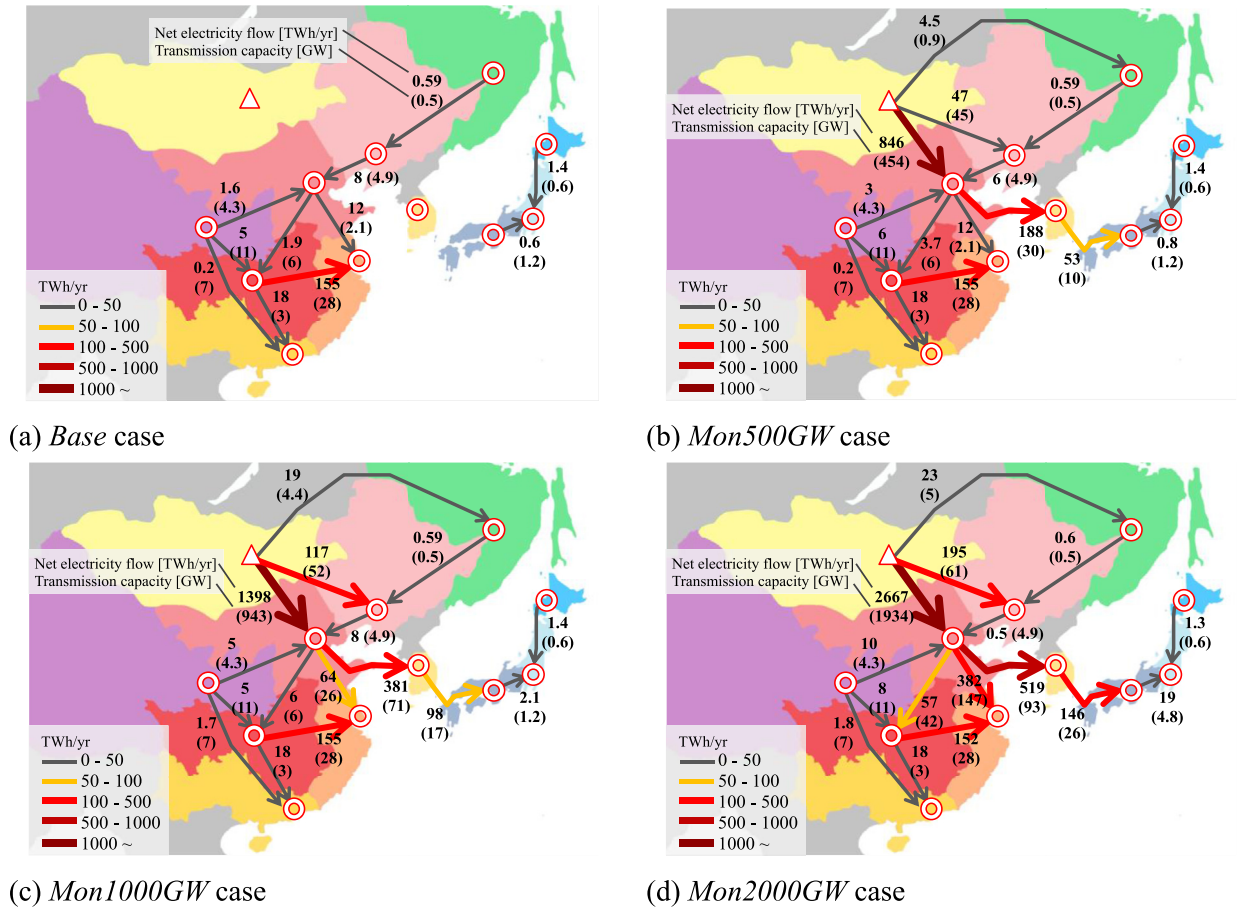

Fig. 9. Cross-boundary electricity transmission in the selected cases. Note: Each flow indicates the electricity delivered to the importing node.

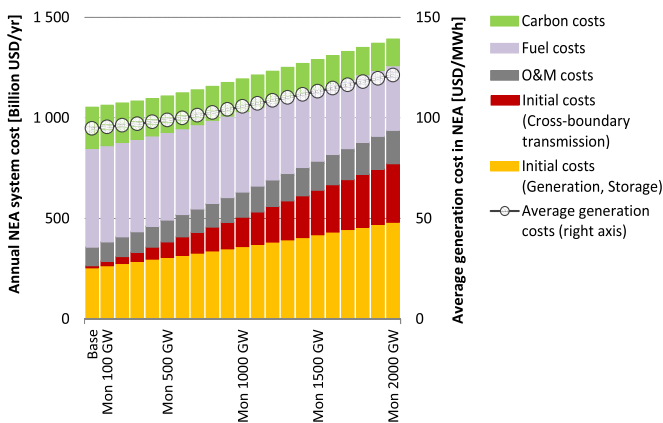

Fig. 10. Annual system cost and average generation cost in Northeast Asia.

equivalent to 121 USD/MWh and 95 USD/MWh, respectively, in average generation cost in NEA.

Fig. 11 shows additional investments in the selected cases. Huge investments are necessary for Mongolian renewables and grid interconnections. Compared to the Base case, additional investments amount to 333B USD in the Mon100 GW case, rising to 3,616B USD in the Mon1000 GW and 7,527B USD in the Mon2000 GW cases. Although massive Mongolian renewables contribute to reducing electricity supply facilities in importing nodes (e.g., a savings of a total of 105B USD in NEA in the Mon1000 GW case), the savings are

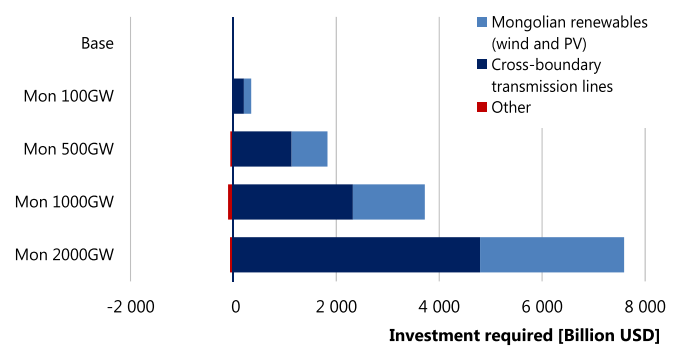

Fig. 11. Additional investments from the Base case.

modest compared to the investments required for renewables in MN and the cross-boundary transmission facilities.

The incremental overall costs (Fig. 10) and huge investments (Fig. 11) may pose significant challenges in terms of financing and implementation. The cost increase implies that the Mongolian renewables concept may not be competitive under a market mechanism unless strong environmental policies are implemented, as discussed later in Section 3.5.1.

3.5. Sensitivity analyses

The results in Sections 3.1–3.4 are based on a number of

assumptions (Section 2.3), where uncertainties exist. Therefore, this section performs sensitivity analyses with a focus on the two factors—cost assumptions and transmission routes through the DPRK—to investigate their effects on the economics of grid interconnections.

3.5.1. Cost assumptions

Fig. 10 suggested that the economic benefits of the large-scale Mongolian renewables depend mainly on fuel and carbon cost savings, while the higher capital costs for the renewables and transmission facilities make the concept less attractive. However, there exist uncertainties in these cost factors; energy prices have shown their volatile nature in the last decade; carbon prices depend heavily on future environmental policies and regulations; and capital costs vary depending on site-specific characteristics. Therefore, in this section, we conduct a sensitivity analysis on these three factors. The author additionally conducted 1,232 calculations in total: three case settings (the *Base*, *Mon100 GW*, *Mon500 GW* and *Mon2000 GW*) × four carbon prices (No carbon price, 100 USD/tCO₂, 200 USD/tCO₂, 300 USD/tCO₂) × eleven fossil fuel prices (−50% compared to the assumption in Section 2.3, −40%, −30%, −20%, −10%, 0% (=“Reference”), +10%, +20%, +30%, +40%, +50%) × seven capital costs of the Mongolian renewables and transmission facilities (−30%, −20%, −10%, 0% (=“Reference”), +10%, +20%, +30%). Other assumptions are the same as shown in Section 2.3.

Fig. 12 illustrates the net economic benefits of the three selected Mongolian renewables cases under each carbon price, fossil fuel price and capital cost setting (positive values, shown in blue, indicate the total system cost reductions compared to the *Base*). The results illustrate the improved economics of the Mongolian renewables cases under higher carbon prices, higher fuel prices or lower capital costs, as each of these factors enhances the relative cost-competitiveness of renewables in Mongolia.

However, the results also suggest that strong emission reduction policies, such as high carbon prices, would be important for implementation. For example, under the reference (“Ref.”) fuel prices and capital costs, carbon prices of 100 USD/tCO₂ would not be enough for the three renewables cases to be economically attractive; nor a carbon price of 200 USD/tCO₂ for the *Mon2000 GW* case. The *Mon100 GW* and *Mon500 GW* cases barely show net benefits with 200 USD/tCO₂, but these benefits become negative with only a 10% fuel cost drop and a 10% capital cost increase (see 200 USD/tCO₂ in Fig. 12a–b). These levels of carbon price are higher than the IEA’s assumed carbon price for 2030 in their 450 Scenario,⁸ also known as the “2 °C Scenario”, which is targeted by the Paris Agreement at the 21st Conference of the Parties of the UNFCCC [44]. IEA assumes higher carbon prices in the longer-term (see the price for 2040 in footnote 8); yet, those prices are still in the range of 100–140 USD/tCO₂, much lower than 200 USD/tCO₂. Massive deployment of Mongolian renewables could be an option for a “beyond 2 °C” policy for the period up to around 2040, according to our analysis. The relevant planning organizations will need to carefully consider long-term energy market and environmental policy trends (such as fuel prices, capital costs and carbon prices) in order to assure that implementation will be beneficial.

3.5.2. The transmission routes through the DPRK

The results in Sections 3.1–3.5.1 do not include the two transmission routes through the DPRK (the dotted lines in Fig. 2) due to large diplomatic uncertainties. The DPRK routes are expected to

improve the economics of interconnections in NEA; for example, the route between CH-NE and KR would allow connecting China and Korea via overhead lines, not via high cost submarine cables. To quantify the economic impacts of the routes’ uncertainties, we additionally simulated the *Mon2000 GW* case considering the DPRK routes. Fig. 13 illustrates the impacts of the route in terms of cross-boundary electricity transmission, generated electricity and system costs. Fig. 13b–c shows the changes from the *Mon2000 GW* case in Sections 3.1–3.4, which does not include the DPRK routes. Our results imply the following two points.

First, the DPRK routes make it more attractive for Japan to import electricity from Mongolia. The net imports of Japan expand to 311 TWh/yr with the route between CH-NE and KR (Fig. 13b), from 146 TWh without the route (Fig. 9d), due to the improved economics of transmission. The incremental imports allow Japan to replace high cost generation, such as gas-fired generation; instead, CH-NE decreases net imports from MN, resulting in the larger coal-fired generation there (Fig. 13b) and higher CO₂ emissions (indicated as increasing carbon costs in Fig. 13c). In contrast to Japan, impacts on Korea are relatively small, as the economy has already expanded its imports and replaced fossil fuel generation even in the cases without the routes.

Second, from an economic perspective, our results imply that there are relatively modest impacts from the availability of the DPRK routes for NEA (Fig. 13c). Total cost in NEA drops by 6B USD/yr, yet these reductions are limited compared to the annual system cost (1,391B USD/yr in the *Mon2000 GW* case; see Fig. 10). The fuel costs saved in JP-E and JP-W are partly offset by the initial costs for additional transmission facilities (for example, between KR and JP-W) and carbon penalties for the incremental coal-fired generation in CH-NE.

Various discussions (for example, WEC [45]) have pointed that the uncertainty of the DPRK routes would be one of the biggest issues for designing and implementing grid interconnections in NEA. Our results suggest the DPRK routes would be economically important to encourage Japan’s involvement. However, the results also imply that the routes do not significantly increase the benefits to the NEA system of integrating massive renewables in Mongolia. Even if the DPRK routes are available, the NEA power system would still face increased costs, similar to the level discussed in Section 3.4. Relevant planning organizations need to note that the cost burdens for renewables in Mongolia and cross-boundary transmission network would still remain as a major barrier to implementation.

4. Conclusions and policy implications

This study quantitatively examined the economic viability of developing the abundant renewable energy in Mongolia for electricity exports. This paper employs a single-year multi-region power system model, which is formulated as a linear program and aims to minimize overall system cost of NEA. We examined twenty-one cases, ranging from the *Base* case to the *Mon2000 GW* case, which assumes 1000 GW of wind turbine capacity and 1000 GW of solar PV capacity in Mongolia, as shown in Table 1. Major results of the selected scenarios are summarized in Table 9. These simulation results provide the following interesting findings regarding the environmental opportunities and economic challenges.

First, from an environmental perspective, renewable energy in Mongolia has a significant potential to decarbonize the NEA power system. Renewables’ share grows from 20% in the *Base* case to 47% in the *Mon2000 GW* case, resulting in the CO₂ emissions reductions from power generation of 36%. In particular, China and Korea are significantly benefited; for example, CO₂ emissions are reduced by more than 35% (2,095 MtCO₂) in the China nodes as the Mongolian

⁸ IEA’s carbon price assumptions for the 450 Scenario are as follows: 75 USD/tCO₂ in 2030 and 125 USD/tCO₂ in 2040 for China and Russia, and 100 USD/tCO₂ in 2030 and 140 USD/tCO₂ in 2040 for Japan and Korea [30].

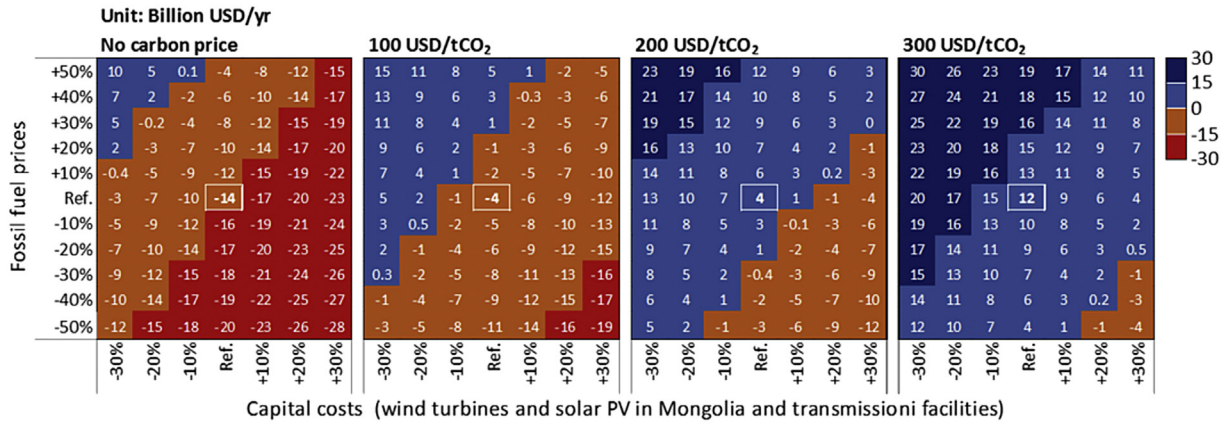

(a) Mon100GW case

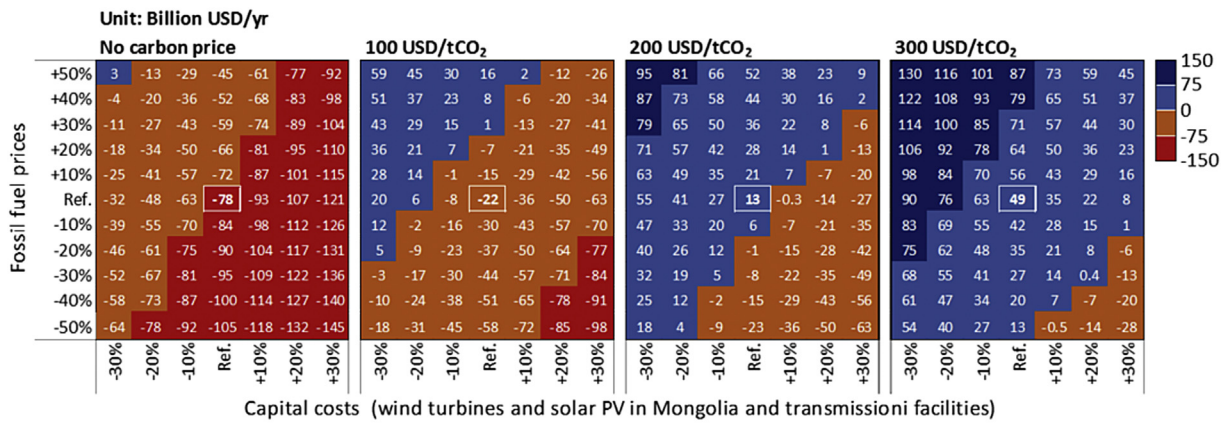

(b) Mon500GW case

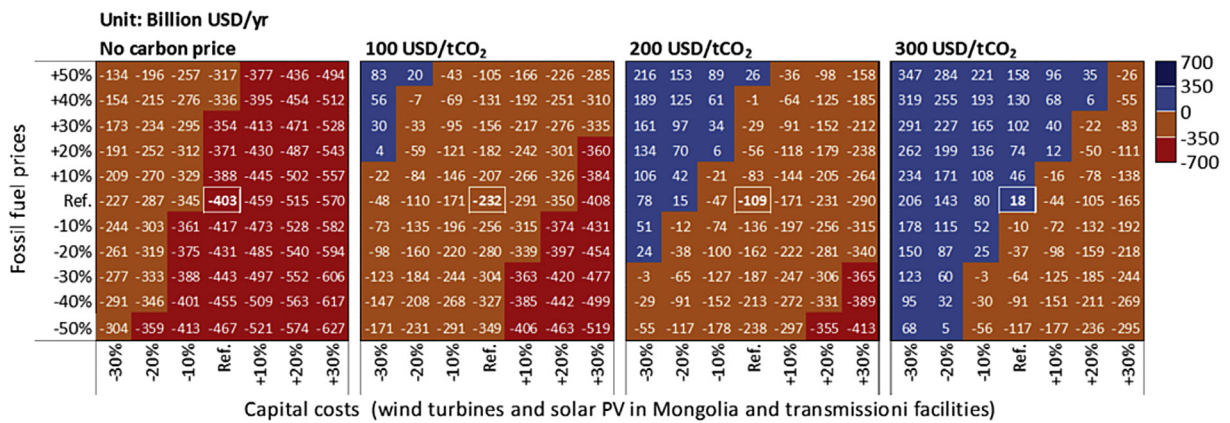

(c) Mon2000GW case

Fig. 12. Economic benefits of the selected Mongolian renewables cases under various carbon price, fossil fuel and capital cost settings.

renewables replace carbon intensive coal-fired generation. On the other hand, the results show relatively modest effects in Japan, with only a 13% reduction even in the *Mon2000 GW* case. This is due to limited electricity imports in JP-H (Hokaido) and JP-E (Eastern Japan). We confirmed that high transmission costs are one of the reasons for the limited imports to Japan (see Appendix). Lower transmission costs would be needed for Japan to enjoy the

environmental benefits of Mongolian renewables.

Second, in contrast to the environmental merits, the results indicate economic challenges for implementation. Massive deployment of Mongolian renewables and cross-boundary transmission lines pushes up the annual system cost by 32%, from 1,053B USD/yr (95 USD/MWh) in the *Base* case to 1,391B USD/yr (121 USD/MWh) in the *Mon2000 GW* case. Massive renewables

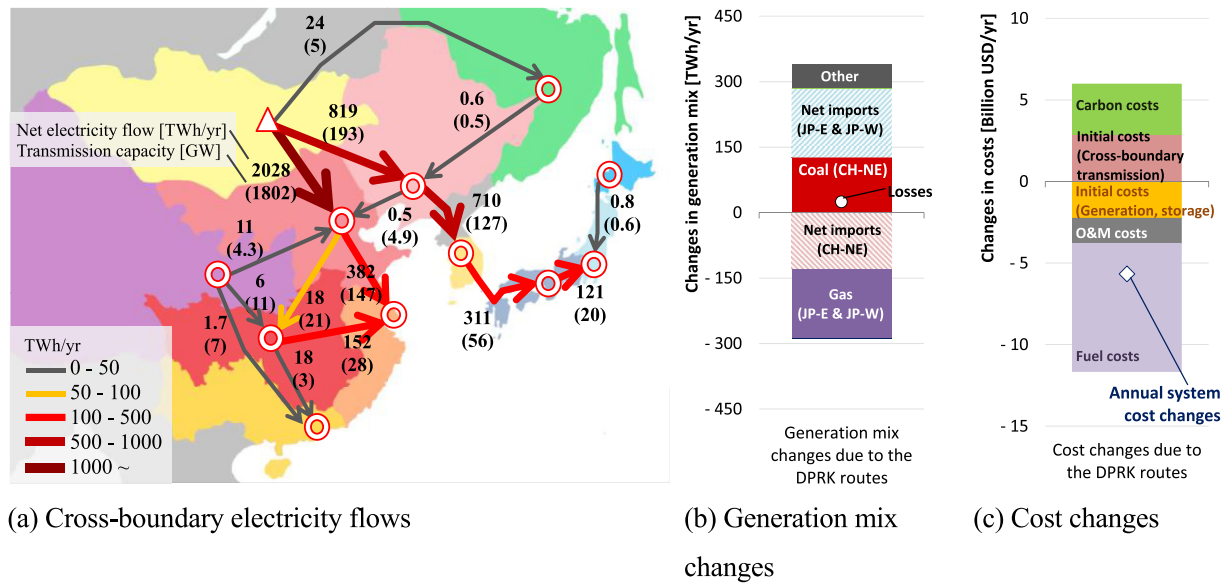

Fig. 13. Effects of the DPRK routes in the *Mon2000 GW* case. Note: “Losses” in Fig. 13b includes losses associated with transmission and electricity storage.

Table 9
Summary of results of the selected cases.

	Base	<i>Mon500 GW</i>	<i>Mon1000 GW</i>	<i>Mon2000 GW</i>
System cost	1,053B USD/yr	1,109B USD/yr	1,194B USD/yr	1,391B USD/yr
Initial costs	265B USD/yr	383B USD/yr	506B USD/yr	772B USD/yr
Fuel costs	490B USD/yr	436B USD/yr	400B USD/yr	322B USD/yr
CO ₂ emissions	6,855 MtCO ₂ /yr	6,057 MtCO ₂ /yr	5,440 MtCO ₂ /yr	4,382 MtCO ₂ /yr
Renewables' share in NEA	20%	29%	35%	47%
Transmission from China to Korea	0 TWh/yr	188 TWh/yr	381 TWh/yr	519 TWh/yr
Transmission from Korea to Japan	0 TWh/yr	53 TWh/yr	98 TWh/yr	146 TWh/yr

significantly contribute to saving fuel costs; however, the benefits are offset by the initial costs for the renewables and transmission lines. The massive deployment of renewables change the cost structure to be more capital intensive due to the huge investments required. Additional investments amount to 3,616B USD for 1000 GW of Mongolian renewables and 7,527B USD for 2000 GW. The relevant planning organizations need to carefully consider how to secure such large investments, taking into account long-term energy prices, capital costs and environmental policy trends in order to assure that implementation will be beneficial, as discussed in Section 3.5.1.

Third, the sensitivity analysis implies that the routes through the DPRK would be economically important to encourage Japan's involvement. On the other hand, the results also show that the routes do not significantly increase the benefits to the whole NEA system of integrating massive renewables in Mongolia. Relevant planning organizations need to note that, even if the routes become available, the cost burdens for renewables in Mongolia and the cross-boundary transmission network would still remain as a major barrier to implementation from an economic perspective.

Turning to priorities for future work, we need to further enhance the model's capabilities and conduct additional analyses in at least two ways. The first would be more detailed modeling of variable renewables and energy storage technologies. If detailed meteorological data (i.e., hourly or more detailed wind speed and sunshine data) is available in each country, future work could address NEA-wide grid integration issues, not only for the renewables in Mongolia but also in other countries, taking into

account the short-term fluctuations in the variable renewables. Additional modeling of energy storage, including hydrogen and heat storage technologies, would also allow a more comprehensive assessment of the use of surplus electricity from variable renewables. The second would be to address energy security issues. To quantify the maximum benefits potentially achievable by developing renewables in Mongolia for power exports, this paper assumes that the NEA countries fully cooperate for regional optimization. Therefore, emergency situations, such as the disruption of electricity trade due to technical or political issues, were out of this research scope. Incorporating energy security aspects into the model, for example, by using stochastic programming techniques, would be an important research contribution in order to comprehensively understand the opportunities and barriers for grid interconnections.

Acknowledgement

The author would like to thank the following former APERC researchers for their suggestions and advice: Dr. Ralph D. Samuelson of the New Zealand Ministry of Transport, and Dr. Aishah Binti Mohd Isa of the Universiti Tenaga Nasional in Malaysia. The author also expresses his appreciation to his colleagues at APERC, especially Mr. Alexey Kabalinskiy and Dr. Jia Hao, for their assistance with data collection. The research reported in this paper was generously supported by Asia Pacific Energy Research Centre (APERC). The views expressed, however, are those of the author and not those of APERC.

Appendix. Additional analysis of the effects of battery and transmission costs on suppression control

As illustrated in Figs. 5–7, with a massive renewables installation in Mongolia (MN), the model selects suppression control there, rather than additional exports or battery storage. To confirm that the high cost of cross-boundary transmission and battery storage is one of the reasons for the suppression, this section performs the sensitivity analysis on these costs under a Mongolian renewables capacity at 2000 GW. Table A.1 shows the case settings. We assume cost reductions in transmission facilities (transmission lines, cables and conversion station) and battery storage.

Table A.1

Case settings regarding the cost of battery systems and transmission facilities.

	Reference	Tra-25%	Tra-50%	Bat-25%	Bat-50%
Wind and PV capacity	Mongolia: 1000 GW each for all cases. Other nodes: same assumptions as Table 1.				
Transmission facility cost reductions	0%	25%	50%	0%	0%
Battery system cost reductions	0%	0%	0%	25%	50%

(Note) The Reference case is the same as the Mon2000 GW case in Table 1.

Fig. A.1 describes generated electricity by node in each case. Suppression control in MN declines when the cross-boundary transmission becomes less costly. For example, the suppression rate (the share of suppression in the total generated electricity) in MN is 21% (849 TWh/yr) in the Reference case, and reduces to 17% (660 TWh/yr) in the Tra-50% case. Lower cost transmission facilities

allow Japan and the Central part of China (CH-C) to expand electricity imports, which contributes to less suppression control and more renewable power exports in MN (see Fig. 9d and Fig. A.2a).

Cost reductions for battery storage also decrease suppression control by facilitating electricity storage of the surplus electricity from wind and PV. In the Bat-50% case, the suppression rate in MN drops to 12% (480 TWh/yr) as shown in Fig. A.1. The additional battery storage is mainly in China-North (CH-N). Battery capacity in CH-N grows to 337 GW in the Bat-50% case, from 110 GW in the Reference case. In contrast with the Chinese nodes, the impacts of battery cost on Korea and Japan is relatively modest as the cross-boundary transmission is still relatively expensive; the electricity

imports of these countries show a level similar to the Reference case (see Fig. 9d and Fig. A.2b).

These results suggest that the model selects suppression control partly due to high battery and transmission costs. Reductions in their costs would allow NEA to accommodate more renewable power from Mongolia.

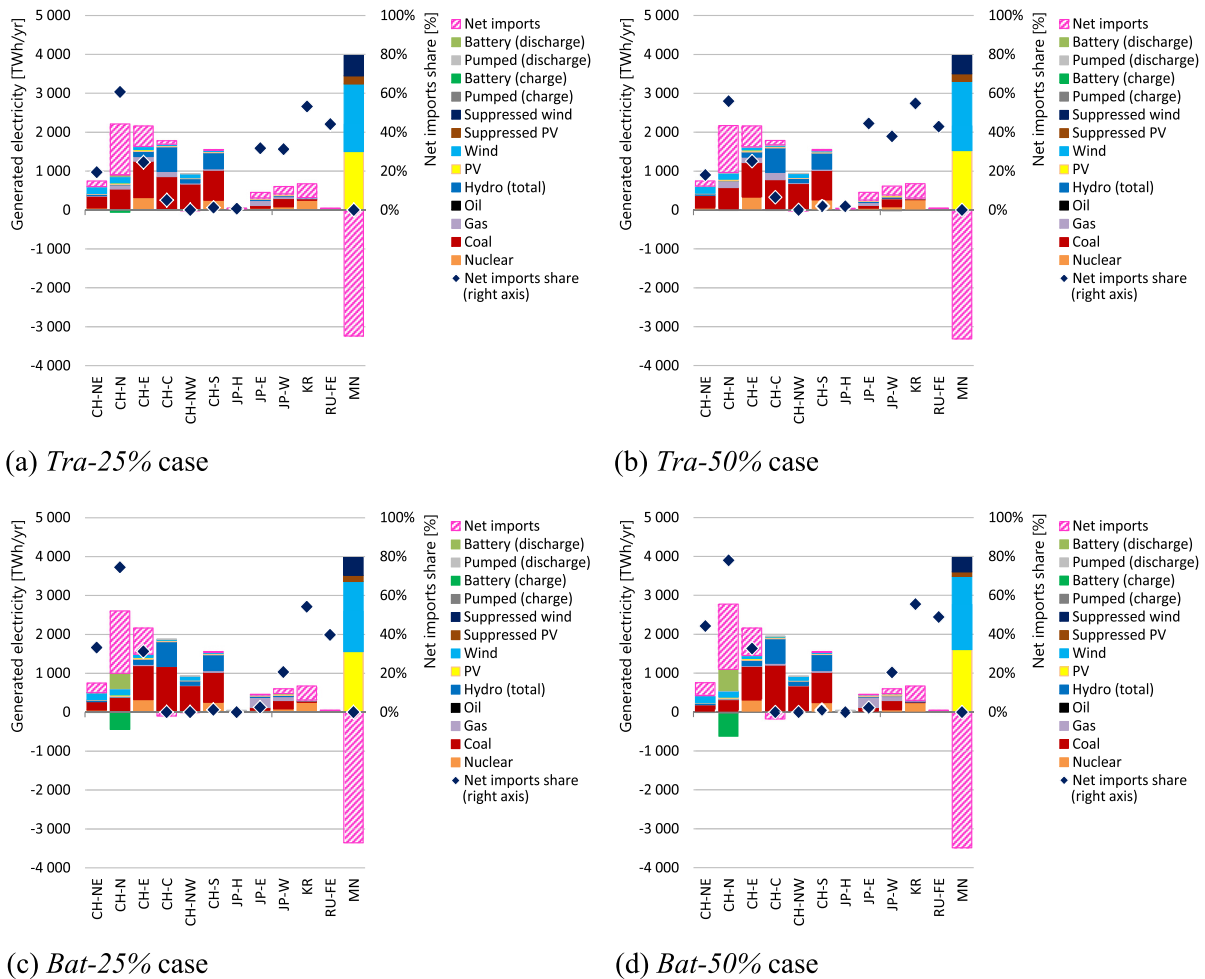

Fig. A.1. Generation in NEA in each case.

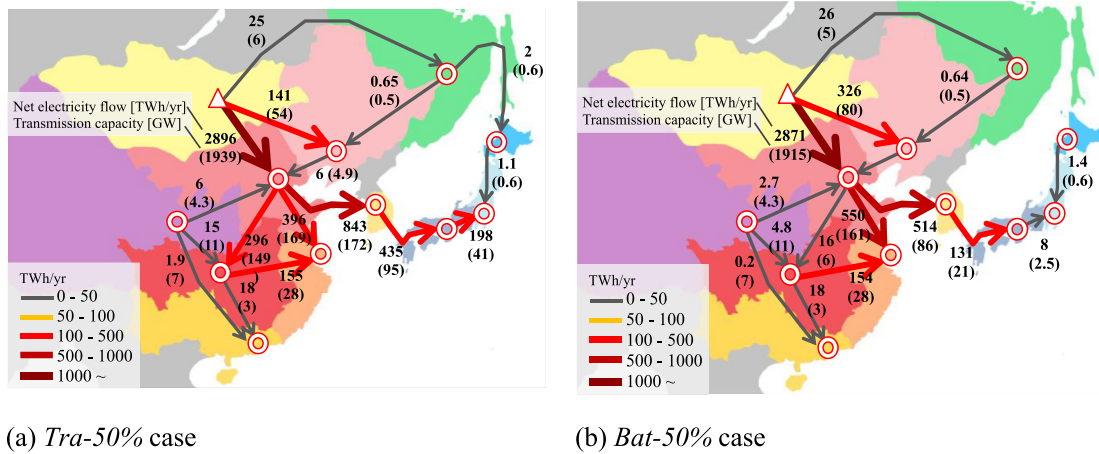

Fig. A.2. Cross-boundary electricity transmission in the selected cases.

References

- [1] IEA, World Energy Statistics and Balances Online Data Service 2015 Edition, International Energy Agency, Paris, 2015.
- [2] METI, International Power Grid Interconnections, 16 Feb 2012 [Online]. Available: http://www.meti.go.jp/committee/sougouenergy/sougou_chiikikanrenkeisen/001_10_00.pdf (Accessed 28 September 2016).
- [3] KEPCO, KEPCO's Future Plans of Northeast Asia Supergrid, 26 June 2014 [Online]. Available: http://www.energycharter.org/fileadmin/DocumentsMedia/Forums/ECF_Ulaanbaatar_2014_S2_Kwang_Hee.pdf (Accessed 15 December 2016).
- [4] SGCC, Connotation of Global Energy Interconnection and Asian Grid Interconnection, 8 Sep 2016 [Online]. Available: http://www.renewable-ei.org/images/pdf/20160908/Wan_Haibin_GlobalEnergyInterconnections.pdf (Accessed 15 December 2016).
- [5] C. Batbayar, The Role of Mongolia for Development of Northeast Asian Super Grid, 2015. Seoul.
- [6] D. Elliott, M. Schwartz, G. Scott, S. Haymes, D. Heimiller, R. Gorge, Wind Energy Resource Atlas of Mongolia, Colorado: NREL/TP-500-28972, 2001.
- [7] Energy Charter, Korea Energy Economics Institute, Energy Systems Institute, Ministry of Energy, Mongolia and Japan Renewable Energy Foundation, Gobitec and Asian Super Grid for Renewable Energies in Northeast Asia, Energy Charter Secretariat, 2014.
- [8] GEIDCO, Overview of GEIDCO, 2016 [Online]. Available: http://www.geidco.org/html/qnycoen/col2015100826/column_2015100826_1.html (Accessed 26th September 2016).
- [9] D.V. Hippel, Estimated Costs and Benefits of Power Grid Interconnections in Northeast Asia, 2001. Prepared for the Northeast Asia Grid Interconnection Workshop, Beijing, China, May-14-16 (2001).
- [10] S. Podkovaľnikov, Study for Russia, Democratic People Republic of Korea, Republic of Korea and China Power Interconnection: Analysis of Current Status, Energy Systems Institute, Siberian Branch, Russian Academy of Sciences, 2002.
- [11] K.-H. Chung, B.H. Kim, Economic feasibility on the interconnected electric power systems in North-east Asia, J. Electr. Eng. Technol. 2 (4) (2007) 452–460.
- [12] L.Y. Chudinova, S. Podkovaľnikov, V. Savel'ev, Prospects of electric energy cooperation between Russia and Northeast Asian countries, Stud. Russ. Econ. Dev. 26 (4) (2015) 403–412.
- [13] T. Otsuki, A.B. Mohd Isa, R.D. Samuelson, Electric power grid interconnections in Northeast Asia: a quantitative analysis of opportunities and challenges, Energy Policy 89 (2016) 311–329.
- [14] APERC, APEC Energy Demand and Supply Outlook, sixth ed., APEC Secretariat, 2016.
- [15] Eurux Energy, Solar Power - Requirements, 2012 [Online]. Available: http://eurux-energy.com/en/solar_power/condition.html (Accessed 6 May 2016).
- [16] JEPIC, Overseas Electric Power Industry Statistics 2015, Japan Electric Power Information Center, Inc., 2015.
- [17] JEPIC, Overseas Electric Power Industry Statistics 2006 (In Japanese), Japan Electric Power Information Center Inc., Tokyo, 2006.
- [18] RAO ES of East, Annual Report 2013, 2013 [Online]. Available: <http://www.rao-esv.ru/en/shareholders-and-investors/companys-reports/annual-reports/> (Accessed 28 March 2016).
- [19] CEPP, China electric Power Yearbook 2014, China Electric Power Press, Beijing, 2014.
- [20] KESIS, Korea Energy Statistics Information System, 2015 [Online]. Available: <http://www.kesis.net/> (Accessed 13 March 2015).
- [21] OCCTO, Summary of Power Producers' Supply Plan and Submission to METI Minister, June 2015 [Online]. Available: <https://www.occto.or.jp/pressrelease/2015/2015-0630-0947-11.html> (Accessed 1 January 2016).
- [22] Energy and Environment Council, Report of Cost Validation Committee (In Japanese), Energy and Environment Council (Prime Minister's Office, Japan), Tokyo, 2011.
- [23] CEC, Annual Development Report of China Power Industry 2014, China Electricity Council, 2014 [in Chinese].
- [24] JAIF, Nuclear Development in China (In Japanese), 21 January 2014 [Online]. Available: http://www.jaif.or.jp/ja/asia/china/china_data.pdf (Accessed 13 March 2015).
- [25] SASIA, Desert Protocol Tests to be Required for PV in Saudi Arabia, 2013 [Online]. Available: <http://saudi-sia.com/desert-protocol-tests-to-be-required-for-pv-in-saudi-arabia/> (Accessed 25 June 2016).
- [26] MIRAI, The Solar Cleaning Robot Is the Key of Solar Electric Generation in Arid Areas, 2016 [Online]. Available: <http://www.miraikikai.jp/#!products-e/cbhz> (Accessed 25 June 2016).
- [27] IEA, CO₂ Emissions from Fuel Combustion 2015 Edition, International Energy Agency, Paris, 2015.
- [28] R. Komiyama, T. Otsuki, Y. Fujii, Energy modeling and analysis for optimal grid integration of large-scale variable renewables using hydrogen storage in Japan, Energy 87 (2015) 537–555.
- [29] METI, Report of Power Generating Costs Working Group, 2015 [Online]. Available: http://www.enecho.meti.go.jp/committee/council/basic_policy_subcommittee/mitoshi/cost_wg/pdf/cost_wg_03.pdf (Accessed 30 May 2015).
- [30] IEA, World Energy Outlook 2015, International Energy Agency, Paris, 2015.
- [31] Qinhuangdao coal network, Qinhuangdao Port Coal Price (In Chinese), 2016 [Online]. Available: http://www.cqcoal.com/Trade/Price/2015/price_2j.jsp?type=17 (Accessed 16 March 2016).
- [32] P. Zhang, Natural Gas Policy in China (In Japanese), 2014 [Online]. Available: <http://eneken.ieej.or.jp/data/5556.pdf> (Accessed 16 March 2016).
- [33] IEEJ, EDMC Statistics (Members Only), 2016 [Online]. Available: <http://eneken.ieej.or.jp/statistics.php> (Accessed 16 March 2016).
- [34] JOGMEC, Survey on the Recent Trends of Coal Mining in Russia, Rail Transport Capacity for Coal, and Cost Competitiveness of Russian Coal in Japan and Aisan Market (In Japanese), 2015 [Online]. Available: http://coal.jogmec.go.jp/result/docs/150708_11.pdf (Accessed 16 March 2016).
- [35] M. Bahrman, B. Johnson, The ABCs of HVDC transmission technologies, IEEE Power Energy Mag. 5 (2) (2007).
- [36] K. Schaber, F. Steinke, T. Hamache, Transmission grid extensions for the integration of variable renewable energies in Europe: who benefits where? Energy Policy 43 (2012) 123–135.
- [37] Deloitte, A Study on Costs and Lead Time for Constructing Transmission Lines, 26 Mar 2012 [Online]. Available: http://www.meti.go.jp/committee/sougouenergy/sougou_chiikikanrenkeisen/003_s01_00.pdf (Accessed 28 March 2016).
- [38] TEPCO, Chuden, Basic Specifications for New Interconnections between Tokyo and Chubu Areas, 6 Nov 2014 [Online]. Available: http://www.tepco.co.jp/corporateinfo/procure/plan/connect/pdf/ACDC_outline-j.pdf (Accessed 31 March 2016).
- [39] METI, Expansion of Regional Grid Interconnections (A Discussion Material for 10th Electricity Supply-Demand Verification Subcommittee of METI), 16 Apr 2015 [Online]. Available: <http://www.meti.go.jp/committee/sougouenergy/>

- kihonseisaku/denryoku_jukyu/pdf/010_09_00.pdf (Accessed 31 March 2016).
- [40] Y. Matsuo, K. Fukasawa, Y. Nagatomi, W. Fujisaki, I. Kutani, N. Seki, Y. Kubota, Quantitative Analysis of Effects of International Power Grid Interconnection in ASEAN Region, January 2015 [Online]. Available: <https://eneken.iej.or.jp/data/5909.pdf> (Accessed 30 June 2015).
- [41] METI, Japan's Electricity Market Deregulation, 2015 [Online]. Available: http://www.meti.go.jp/english/policy/energy_environment/electricity_system_reform/pdf/201506EMR_in_Japan.pdf (Accessed 25 June 2016).
- [42] SGCC, China electric Power News: Interconnection Capacity of State Grid Liaoning Electric Power Supply Company Leaps, Oct 2015 [Online]. Available: http://www.ln.sgcc.com.cn/html/main/col35/2015-10/20151020102333268347627_1.html (Accessed 1 April 2016).
- [43] L. Bird, J. Cochran, X. Wang, Wind and Solar Energy Curtailment: Experience and Practices in the United States, NREL/TP-6A20–60983, 2014.
- [44] UNFCCC, Adoption of the Paris Agreement, in COP21, Paris, 2015.
- [45] WEC, North Korea holds key to East Asian, Super-grid 15 (Oct 2013) [Online]. Available: <https://www.worldenergy.org/news-and-media/news/north-korea-holds-key-to-east-asian-super-grid/> (Accessed 6 April 2016).
- [46] F. Steinke, S. Wolfrum, C. Hoffmann, Grid vs. storage in a 100% renewable Europe, *Renew. Energy* 50 (2013) 826–832.
- [47] Y. Li, Z. Lukszo, M. Weijnen, The impact of inter-regional transmission grid expansion on China's power sector decarbonization, *Appl. Energy* 183 (2016) 853–873.
- [48] B.-W. Yi, J.-H. Xu, Y. Fan, Inter-regional power grid planning up to 2030 in China considering renewable energy development and regional pollutant control: a multi-region bottom-up optimization model, *Appl. Energy* 184 (2016) 641–658.
- [49] T. Otsuki, R. Komiyama, Y. Fujii, Study on surplus electricity under massive integration of intermittent renewable energy sources, *IEEJ Trans. Power Energy* 5 (135) (2014) 299–309.
- [50] J. Ahn, J. Woo, J. Lee, Optimal allocation of energy sources for sustainable development in South Korea: focus on the electric power generation industry, *Energy Policy* 78 (2015) 78–90.
- [51] S.Y. Park, B.-Y. Yun, D.H. Lee, D.G. Choi, An analysis of the optimum renewable energy portfolio using the bottom-up model: focusing on the electricity generation sector in South Korea, *Renew. Sustain. Energy Rev.* 53 (2016) 319–329.
- [52] P. Lombardi, T. Sokolnikova, K. Suslov, N. Voropai, Z. Styczynski, Isolated power system in Russia: a chance for renewable energies? *Renew. Energy* 90 (2016) 532–541.