



**Asia-Pacific
Economic Cooperation**

The Concept of the Low-Carbon Town in the APEC Region

Sixth Edition

**Volume II
Low-Carbon Measures**

November 2016

APEC Energy Working Group

APEC Project: EWG 01 2015A
APEC Low-Carbon Model Town (LCMT) Project - Phase 6

Produced by
APEC Low-Carbon Model Town Task Force

Katsushi Takehiro
Ministry of Economy, Trade and Industry, Japan

Asia Pacific Energy Research Centre
Inui Building, Kachidoki, 1-13-1, Kachidoki,
Chuo-ku, Tokyo, 104-0054, Japan
Phone: (+81) 3-5144-8551
E-mail: master@aperc.iecej.or.jp
Website: <http://aperc.iecej.or.jp>

For
Asia Pacific Economic Cooperation Secretariat
35 Heng Mui Keng Terrace, Singapore 119616
Phone: (65) 6891-9600
E-mail: info@appec.org
Website: <http://www.appec.org>

© 2016 APEC Secretariat

APEC#216-RE-01.27

The Concept of the Low-Carbon Town in the APEC Region
Sixth Edition
Volume II
Low-Carbon Measures

Contents

1. Low-Carbon Measures and Their Applicability.....	3
2. Low-Carbon Measures with Case Examples.....	8
(1) Cogeneration System/Combined Heat and Power/Trigeneration	9
(2) Using Sea/River Water.....	13
(3) District Heating and Cooling (DHC)	15
(4) Sunlight Reflection, Shading and Thermal Insulation.....	17
(5) Façade Engineering	19
(6) Natural Ventilation	21
(7) Daylight Use plus Lighting System	23
(8) Hybrid of Natural Ventilation plus Air Conditioning.....	25
(9) High-efficient Heat or Cooling Source plus Thermal Storage.....	27
(10) Waste Heat from Sewage Treatment Plant	30
(11) Hydroelectric Power Generation	32
(12) Waste Heat from Incineration Plants	34
(13) Solar Power Generation.....	36
(14) Solar Heating & Cooling.....	39
(15) Biomass Power Generation	41
(16) Geothermal Power Generation	45
(17) Wind Power Generation.....	47
(18) Fuel Cell	50
(19) Transportation (Establishment of Public Transportation Network).....	53
(20) Local Transportation System (Bus, LRT, etc.).....	55
(21) Electrically Driven Vehicle.....	58
(22) Infrastructure for Electrically Driven Vehicle.....	60
(23) Community Cycle Sharing	62
(24) Smart Grid.....	64
(25) Community Energy Management System	68

(26) Home Energy Management System	71
(27) Factory Energy Management System	73
(28) EV Charging Management Solution	75
(29) Demand Side Management	77
(30) Simulation Results for CO ₂ Emission Reduction (Central TOKYO 7 Wards Area).....	79

1. Low-Carbon Measures and Their Applicability

Classification of Measures			Low-carbon Measure	Applicability as per Type of Town ^{Note 1)}				Case	
Supply / demand	Major Classification	Minor Classification		I	II	III	IV	No.	
				Demand	Composition of urban space	Transit Oriented Development (TOD)	H	H	M
	Environment space development	Green way network	H	H		H	M		
			Underground space network	M	L	X	X		
	Buildings	Reducing heat loads	Reflection of solar energy and heat insulation, high solar-reflectance paint for roof, shading, advanced glazing, management of air leakage when heating or cooling; installation of very efficient appliances and equipment to cut internal heat generation	H	H	H	H	(4) (5) (31)	
			Highly efficient facility systems	Highly efficient heat source plus heat storage	H	H	H	H	(9)
			Equipment installed at facilities	Fuel cells, energy storage, etc.	H	H	M	M	
			Passive energy design & equipment	day light use, natural ventilation,	H	H	H	M	(6) (7) (8)
		Environmentally related infrastructures	Urban climate	Micro climate, heat island management	H	M	M	X	
			Wastes	Collecting waste, recycling resources	H	H	H	H	
	Using energy (bio gas), using sewage sludge			M	M	L	H		
	Water supply / sewage		Re-using treated waste water Using rainwater, storage Pump efficiency	H	H	M	L		
		Reducing pollution	Treating exhausts, contaminated soils (Treating waste water is included in sewage.)	H	H	H	H		

Note 1) H: Potentially highly effective M: Potentially effective

L: Potentially less effective or difficult to apply X: Not effective at all or unlikely to apply

*EMS=Energy Management System

BEMS=Building Energy Management System

HEMS=Home Energy Management System

FEMS=Factory Energy Management System

Note 2) Type of Towns

I Urban (Central Business District: (CBD))

II Urban (Commercial/Industrial Oriented Town)

III Urban (Residential Oriented Town)

IV Rural

Classification of Measures			Low-carbon Measure	Applicability as per Type of Town ^{Note 1)}				Case
Supply / demand	Major Classification	Minor Classification		I	II	III	IV	No.
				Demand	Transportation system	Public transportation systems	Public transportation network	M
Intra-district transportation system (busses, LRT, etc.)	H	H	H				L	(20)
Short-distance transportation systems	Intra-city community bicycle (and electric bike)	H	H			H	L	(23)
	Short-distance transportation system	H	H			H	L	
Vehicles	Electrically driven vehicle	M	M			M	M	(21) (29)
	EV bus	M	M			M	M	(22)
	Natural gas-driven vehicles, etc.	M	M			M	M	
EV-related hardware	Fast charger, small battery	M	M			M	M	
Both supply and demand	Management	Energy management systems(EMS)*	Energy monitoring, diagnostic and management systems, BEMS *(HEMS, FEMS)	H	H	H	H	
			Zero Energy Building(ZEB)	M	M	H	H	
			Area EMS	H	H	H	H	(26)
	Smart grid system (mainly for electric power system)	Power control systems	Power monitoring control system	H	H	M	L	
			Power stabilization system	H	H	M	L	
		Network	Network infrastructures	H	H	M	L	(28)
			Network-related technology, communication modules, measuring systems, etc.	H	H	M	L	
	Smart energy system (energy integration)		Smart energy system	H	H	M	L	(24)

Note 1): H: Potentially highly effective M: Potentially effective

L: Potentially less effective or difficult to apply X: Not effective at all or unlikely to apply

*EMS=Energy Management System

BEMS=Building Energy Management System

HEMS=Home Energy Management System

FEMS=Factory Energy Management System

Classification of Measures			Low-carbon Measure	Applicability as per Type of Town ^{Note 1)}				Case
Supply / demand	Major Classification	Minor Classification		I	II	III	IV	No.
				Supply	Generating / distributing power	Infrastructures for generating/ storing power	Distributed power facility– rooftop PV, storage suits III and IV too	M
Cogeneration system	H	H	L				L	(1)
Large-scale power storage, etc. may be located in III or IV for exports	M	M	L				L	
District energy (heat supply)	District heating / cooling	H	H		M	L	(3)	
Untapped energy	Using sea/river/sewage water	H	H		M	L	(2)	
	Using waste heat from waste incineration plants	H	H		M	M	(12)	
	Using waste heat from sewage treatment plants	H	H		M	L	(10)	
	Using waste heat from factories	M	M		M	X		
Renewable energy	Solar power generation (mega solar power generation)	M	M		M	M	(13)	
	Using solar heat (large-scale solar heat)	M	M		M	M	(14)	
	Biomass power generation (biogas power generation, etc.)	L	L		L	M	(15) (25)	
	Wind power generation	L	L		L	H	(17)	
	Geo-thermal power generation	L	L		L	M	(16)	
	Hydroelectric power generation (small- and middle-scale)	L	L		L	M	(11)	

Note 1): H: Potentially highly effective M: Potentially effective

L: Potentially less effective or difficult to apply X: Not effective at all or unlikely to apply

2. Low-Carbon Measures with Case Examples

(1) Cogeneration System/Combined Heat and Power/Trigeneration

Classification of Measures			Low-carbon Measure	Applicability as per Type of Town			
Demand/ Supply	Major Classification	Minor Classification		I	II	III	IV
Supply	Generating/ distributing power	Infrastructures for generating/ storing power	Cogeneration System(CHP)	H	H	L	L

Overview of Measures and Applicability

- Cogeneration is a system that generates electricity onsite where needed and simultaneously makes efficient use of generated heat for space heating, cooling, hot-water supply, steam, etc. Sometimes cogeneration is called combined heat and power or, when cooling is provided as well as heat and power, 'trigeneration'.
- Cogeneration has a wide range of application for a variety of areas and systems that use heat, including those for households/businesses, industries, large cities, middle cities, farming villages, etc., as well as district cooling/heating (district-scale use) and smart energy systems. As for its application in farming villages, there are cases where this system is used as in trigeneration using electricity, heat and CO₂ for greenhouse cultivation. Cogeneration can work in tandem with renewable energy to provide back-up power. Operated with reliable fuel supply, such as middle-pressure city gas pipelines, cogeneration can contribute to the users' 'Business and Living Continuity Plan'* as emergency power and heat supply systems.

* See more at the website of the Centre for the Protection of National Infrastructure
<http://www.cpni.gov.uk/Security-Planning/Business-continuity-plan/>

Expected CO₂-Reducing Effect

Compared with conventional systems (thermal power + boilers), it can reduce CO₂ emissions by about 30-40% or more.

Portfolio of CHP

- > **CHP**: Realize higher generating efficiency than thermal power plants
- > **FC**: Contribute to energy saving and CO₂ reduction with high efficiency

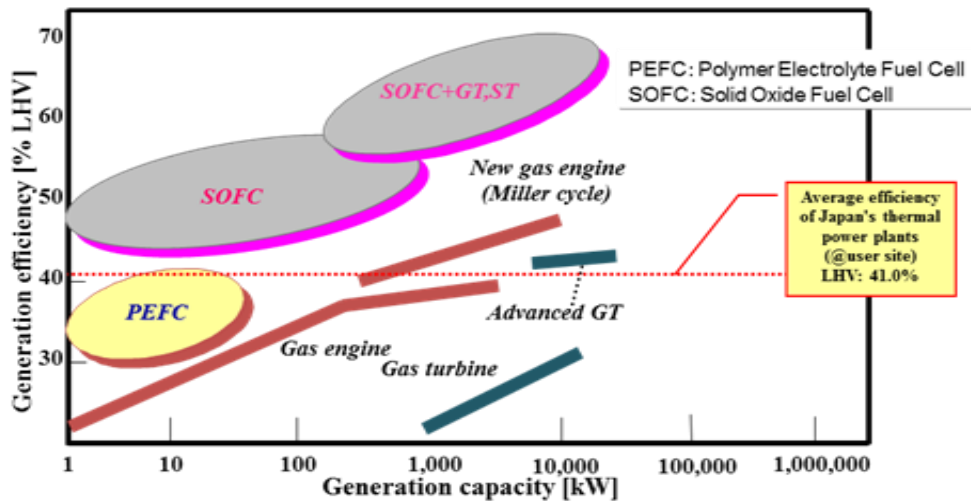

Examples of Application

- Around 10.0 million kW of electricity generation capacity using cogeneration in total has been introduced in Japan (in stock). March 2014.
(http://ace.or.jp/web/works/works_0050.html)

Schematic Diagram of the System, etc.

- Schematic diagram of the system

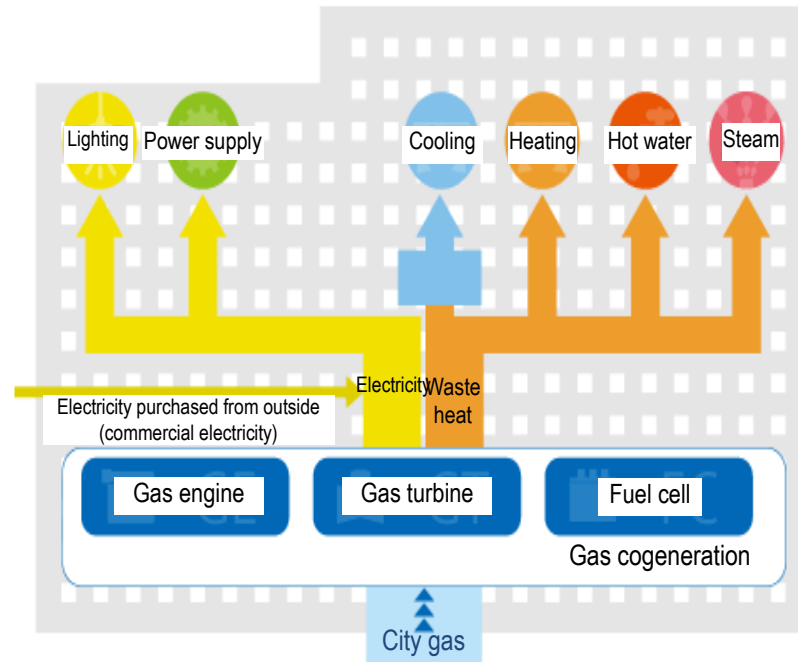

The generated electricity is combined with that purchased from outside and is supplied to the building.

● The energy/cost-saving performance of gas cogeneration

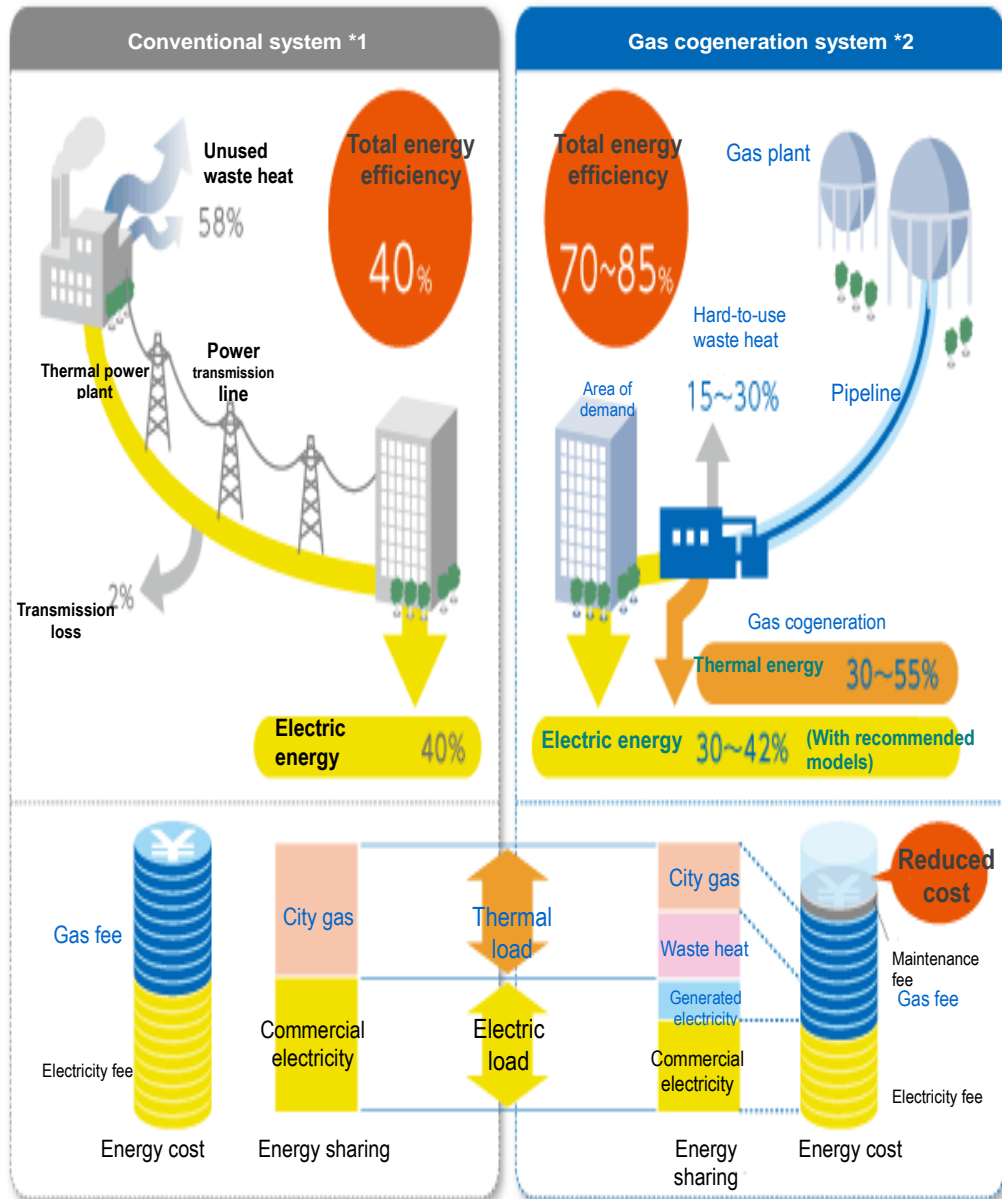

*1 Lower Heating Value (LHV) standard. The thermal efficiency and total loss of thermal power plants were calculated on the basis of the operation performance of nine (9) power utilities and wholesale power utilities in 2003FY (The Working Group on Energy-Saving Standards, September 2005).

*2 The efficiency of gas cogeneration system is an example based on LHV standard.

(2) Using Sea/River Water

Classification of Measures			Low-carbon Measure	Applicability as per Type of Town			
Demand/ Supply	Major Classification	Minor Classification		I	II	III	IV
Supply	Untapped energy		Using sea/river water	H	H	M	L
Overview of Measures and Applicability							
<ul style="list-style-type: none"> As sea/river water temperature is stable and is lower in summer and higher in winter than the atmospheric temperature, it will contribute to improving energy efficiency, both as a coolant of heat pumps used in heat-source equipment for cooling, and as heat-source water for heat pumps for heating/hot-water supply. Heat pump efficiency is improved as the temperature difference between condenser and evaporator is reduced. As the use of seawater requires countermeasures for salt damage to equipment and for marine organisms and the use of river water requires drought management measures, etc., it is a common practice to combine the use of sea/river water with large-scale facilities, such as district heat-supply systems. 							
Expected CO₂-Reducing Effect							
<ul style="list-style-type: none"> It is expected that CO₂ will be reduced through improving energy efficiency in cooling/heating and hot-water supply in the relevant communities. 							
Examples of Application							
<ul style="list-style-type: none"> Examples of applications for river-water temperature: Hakozaki (Tokyo), north area of Toyama Station (Toyama), Nakanoshima (Osaka), Temmabashi (Osaka), Ohkawabata River City (Tokyo) in Japan and ANZ Bank HQ (Melbourne) in Australia Examples of applications for sea-water temperature: Chubu Centrair International Airport (Aichi), Osaka Cosmosquare (Osaka), Sunport Takamatsu (Kagawa), Seaside Momochi Beach Park (Fukuoka) There is less of a record of new operation result recently. The construction cost tends to be high because of large-scale construction work. 							

Schematic Diagram of the System, etc.

- System making use of the temperature difference from river water

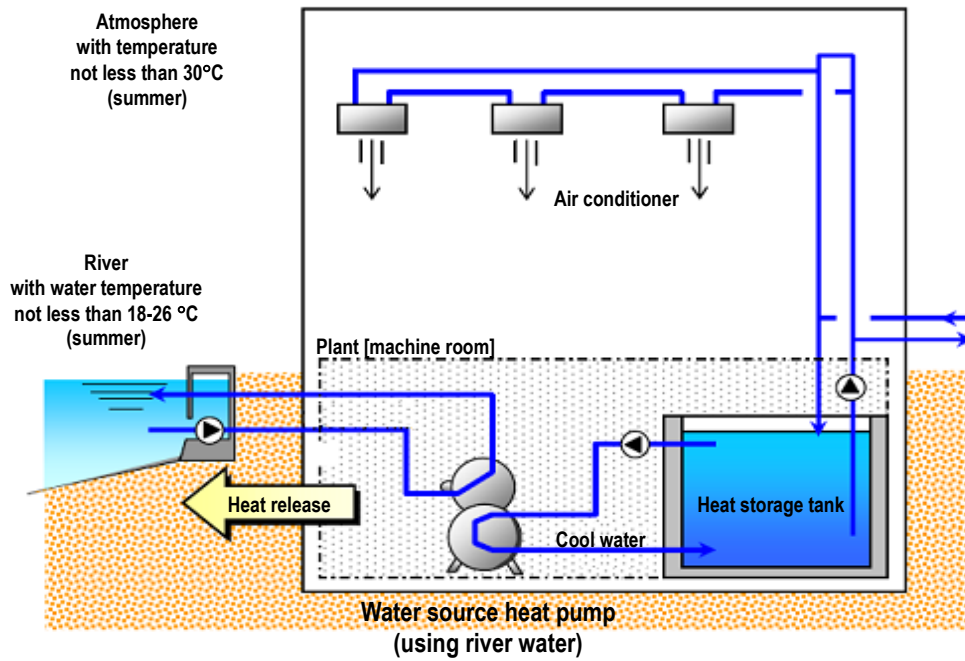

Source : 'An Investigative Report on District-Scale Energy Use', March 2005.

(3) District Heating and Cooling (DHC)

Classification of Measures			Low-carbon Measure	Applicability as per Type of Town			
Demand/ Supply	Major Classification	Minor Classification		I	II	III	IV
Supply	District energy (heat supply)		District heating and cooling (DHC)		H	M	L
Overview of Measures and Applicability							
<ul style="list-style-type: none"> ● It connects multi-purpose buildings in certain urban districts via a thermal pipeline network, and supplies cooling/heating media from district energy supply plants in an efficient manner. ● By means of this system, the area receives not only energy-savings, but also a variety of co-benefits, such as energy security, labour savings, efficient use of building spaces, pollution-abatement, reduction of urban heat-island effect, prevention of urban disasters, etc. ● It also contributes to effective use of unused thermal energy in urban areas, such the use of waste heat from incineration plants. ● Care must be taken to minimise pipe losses and pumping energy. ● Requires strong district policy. 							
Expected CO₂-Reducing Effect							
<ul style="list-style-type: none"> ● Compared with individual (heat source) systems, primary energy consumption can be reduced by 10%-14% *subject to climate. Further reduction of energy consumption (by not less than 20%) can be realised by utilising unused energy, contributing to a significant reduction of CO₂. <p>* 'District-Scale Utilisation of Unused Energy - the Current Status of Heat Supply and the Direction towards the Next Generation', Ministry of Economy, Trade and Industry. March 2008.</p>							
Examples of Application							
<ul style="list-style-type: none"> ● Shinjuku Sub-center, Marunouchi District, Roppongi Hills, Tokyo, Osaka Senri New Town Chuo District, etc. ● Vancouver's Neighbourhood Energy Utility http://vancouver.ca/docs/planning/renewable-energy-neighbourhood-utility-factsheet.pdf ● James Cook University, Queensland, Australia – district cooling on campus 							

Schematic Diagram of the System, etc.

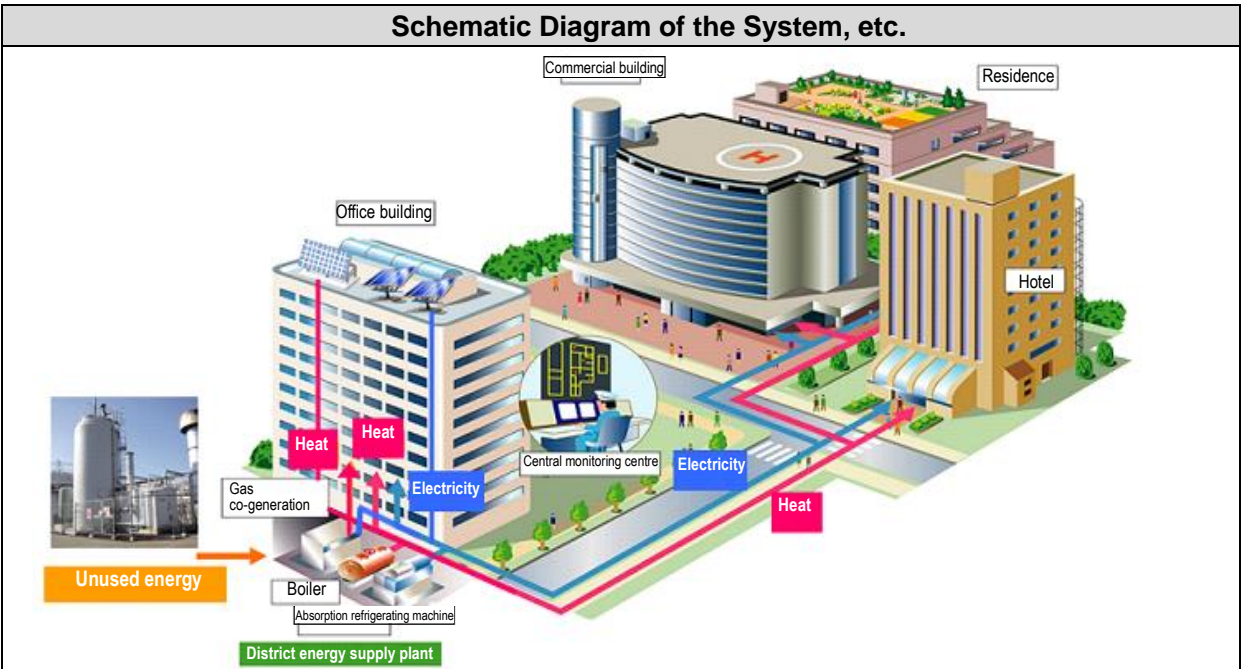

● Example of a Regional Cooling/Heating Plant

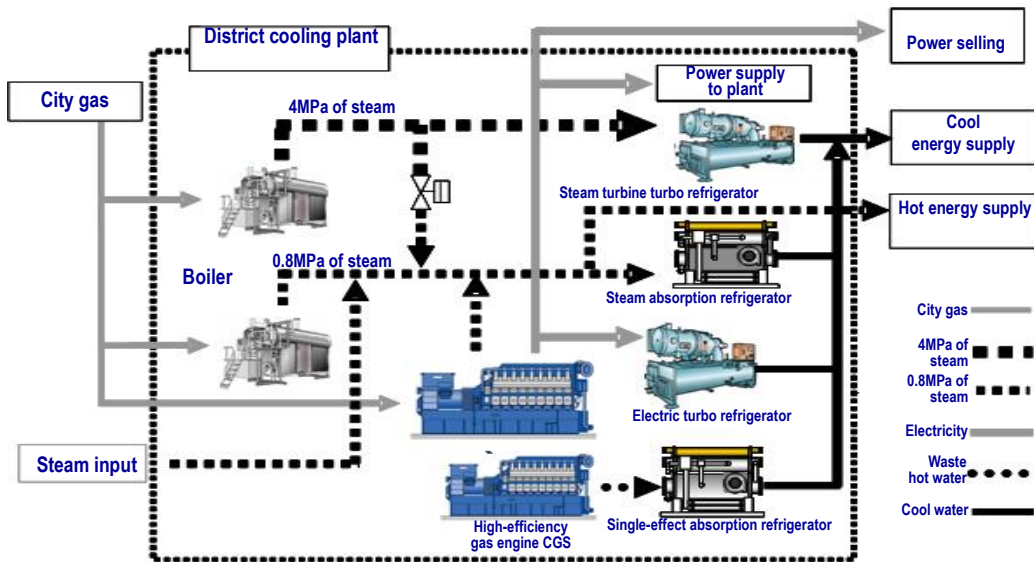

(4) Sunlight Reflection, Shading and Thermal Insulation

Classification of Measures			Low-carbon Measure	Applicability as per Type of Town			
Demand/ Supply	Major Classification	Minor Classification		I	II	III	IV
Demand	Building	Reducing load	Sunlight reflection, shading and thermal insulation	H	H	H	H
Overview of Measures and Applicability							
<ul style="list-style-type: none"> ● Insulation reduces heat flow through building envelope. ● Solar radiation reaching a building's rooftop is converted into heat, which causes higher room temperatures and rising air-conditioning costs. Thus, applying high solar-reflectance paint for roof surfaces prior to the conversion of solar radiation into heat is effective in controlling rising room temperatures and lowering air-conditioning energy requirements. The same measure is similarly effective for roads and sidewalks and the rooves of public transport vehicles (e.g., buses, trains and trams). ● Sunlight shading is very effective in reducing thermal load entering a building. As the solar elevation changes according to its bearing, the type of suitable eaves or blinds also varies. In planning sunlight shading, it is necessary to take the building exterior into account so that sunlight will be effectively shaded. ● Shutting off sunlight on the outer side of a building is more effective. External blinds installed on the outer side of a building helps to reduce the thermal load. They serve to adjust natural lighting when the blinds are designed to change their angles automatically according to the solar elevation. ● Planting vegetation around a building cuts direct sunlight off from the concrete surface and takes effect on controlling the rise in the air temperature around the building because of evapo-transpiration effect. ● Air leakage can be a major contributor to energy waste, especially in strong winds. 							
Expected CO₂-Reducing Effect							
<ul style="list-style-type: none"> ● Power consumption cuts are expected due to the reduction of air conditioning load owing to the lowered temperature inside the building and natural lighting. As a result, it reduces CO₂ emissions and peak energy demand. 							
Examples of Application							
<ul style="list-style-type: none"> ● Itoman city Municipal Office, Institute for Global Environmental Strategies (IGES) Main Office Building, Across Fukuoka (Commercial-Office-Cultural Complex) ● Public Works Department HQ, Jakarta (around 90 kWh/square metre/year in hot humid climate) 							

Schematic Diagram of the System, etc.

- Itoman city Municipal Office



- Institute for Global Environmental Strategies (IGES)

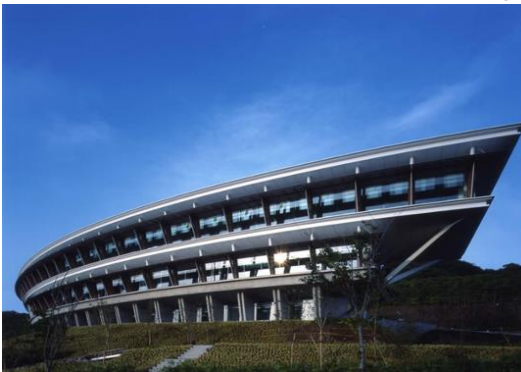

- Across Fukuoka

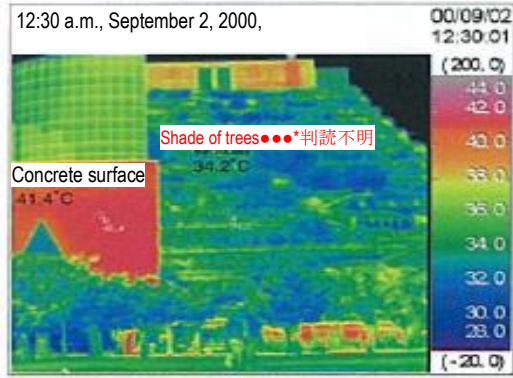

(5) Façade Engineering

Classification of Measures			Low-carbon Measure	Applicability as per Type of Town			
Demand/ Supply	Major Classification	Minor Classification		I	II	III	IV
Demand	Buildings	Reducing heat load	Façade engineering	H	H	M	L
Overview of Measures and Applicability							
<ul style="list-style-type: none"> ● The façade engineering refers to the technology of reducing thermal load from outside by applying high heat characteristics to the window and outer wall which constitute a façade. ● The important component is high-performance glass, such as the duplex glass (double glazing) containing air space between two pieces of glass and low-e glass with specific coating for blocking radiant heat from traveling through. These types of glass also enhance indoor environmental performance around the windows. ● One of advanced approach is the “air flow windows”. They improve the thermal environment nearby the windows. The air flow windows creates a kind of vertical airflow layer inside the double-layered glass equipped with a built-in blind and avoid the heat transfer with high efficiency between the inside and outside of buildings 							
Expected CO₂-Reducing Effect							
<ul style="list-style-type: none"> ● The simulation has conducted to compare result the peak load of the perimeter and annual thermal load between ordinary glass only and low-e glass plus eaves. The result shows that the employment of eaves plus low-e glass cuts the peak load by 43%, indicating that approximately 16% of thermal load will be removed annually. The potential of load reduction varies with climate and exposure to sun. 							
Examples of Application							
<ul style="list-style-type: none"> ● Iidabashi First Building in Tokyo, Japan, etc. 							

Schematic Diagram of the System, etc.

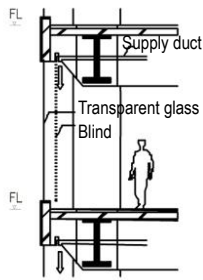

The load around the window is handled by the air conditioner. In winter, some devices such as a panel heater is required because cold draft is generated.



Iidabashi First Bldg.

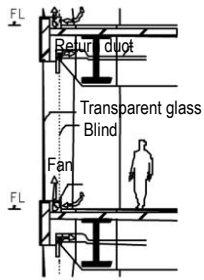

By creating an air curtain barrier between the glass and the blind by a fan, the thermal load generated around the window is collected in order to cut in-room load.



PCP Marunouchi

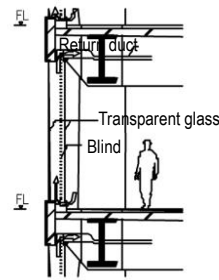

The thermal load around the window is contained inside the Air Flow, and then collected by the air taken from the slits of sashes in the room in order to cut in-room load.



JR East Japan Head Office

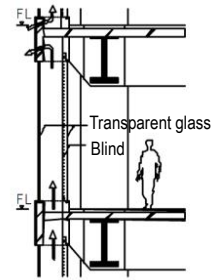

In summer, open air is taken in from the slits on the outer wall to naturally ventilate thermal load accumulated inside the double skin. In winter, open air is shielded off to collect heat.



Chiba Prefecture Autonomous Hall

(6) Natural Ventilation

Classification of Measures			Low-carbon Measure	Applicability as per Type of Town			
Demand/ Supply	Major Classification	Minor Classification		I	II	III	IV
Demand	Buildings	Passive energy design & equipment	Natural ventilation	H	H	H	H
Overview of Measures and Applicability							
<ul style="list-style-type: none"> ● The mid-term air-conditioning energy can be reduced by planning to take natural wind into rooms, for instance by installing apertures or opening-closing windows effectively or natural ventilation voids inside the building. ● The void enables natural air flow even during calm conditions. (The natural ventilation by the difference in temperatures between tops and bottoms.) Moreover, natural ventilation can be effectively obtained no matter which direction the wind blows. (The wind shielding board prompts natural ventilation as a negative pressure zone is created when the wind flows through the upper part). Example: Meiji University Liberty Tower (second figure). ● Natural ventilation using staircases can also produce the same effect as installing natural ventilation voids and wind shielding boards. (When air is calm, ventilation is enabled naturally by the difference in temperatures between upper and lower part of the staircases. When a wind shielding board is mounted on the top, a negative pressure zone is created as the wind passes through the upper part, thereby allowing natural ventilation free of the wind direction. (Bottom figure) ● Care is needed if outdoor air is polluted or if the noise level is high. Fire risk must be managed. Also if the ventilation system leads to increased uncontrolled leakage of air when the building is being heated or cooled, savings can be offset by waste. As fan efficiencies improve and cost of onsite renewable energy generation reduces, the use of powered ventilation can be easier and cheaper overall as complexity of building envelope can be reduced. 							
Expected CO₂-Reducing Effect							
<ul style="list-style-type: none"> ● Air-conditioning load can be reduced. 							
Examples of Application							
<ul style="list-style-type: none"> ● Meiji University Liberty Tower, Tokyo, Japan 							
Schematic Diagram of the System, etc.							

- Natural ventilation using the staircases, Sagamihara Campus, Aoyama Gakuin University

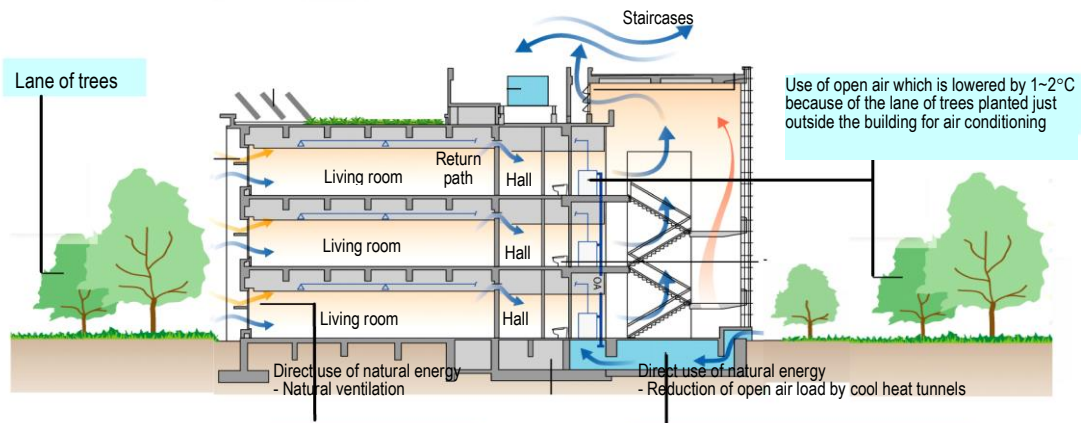

-

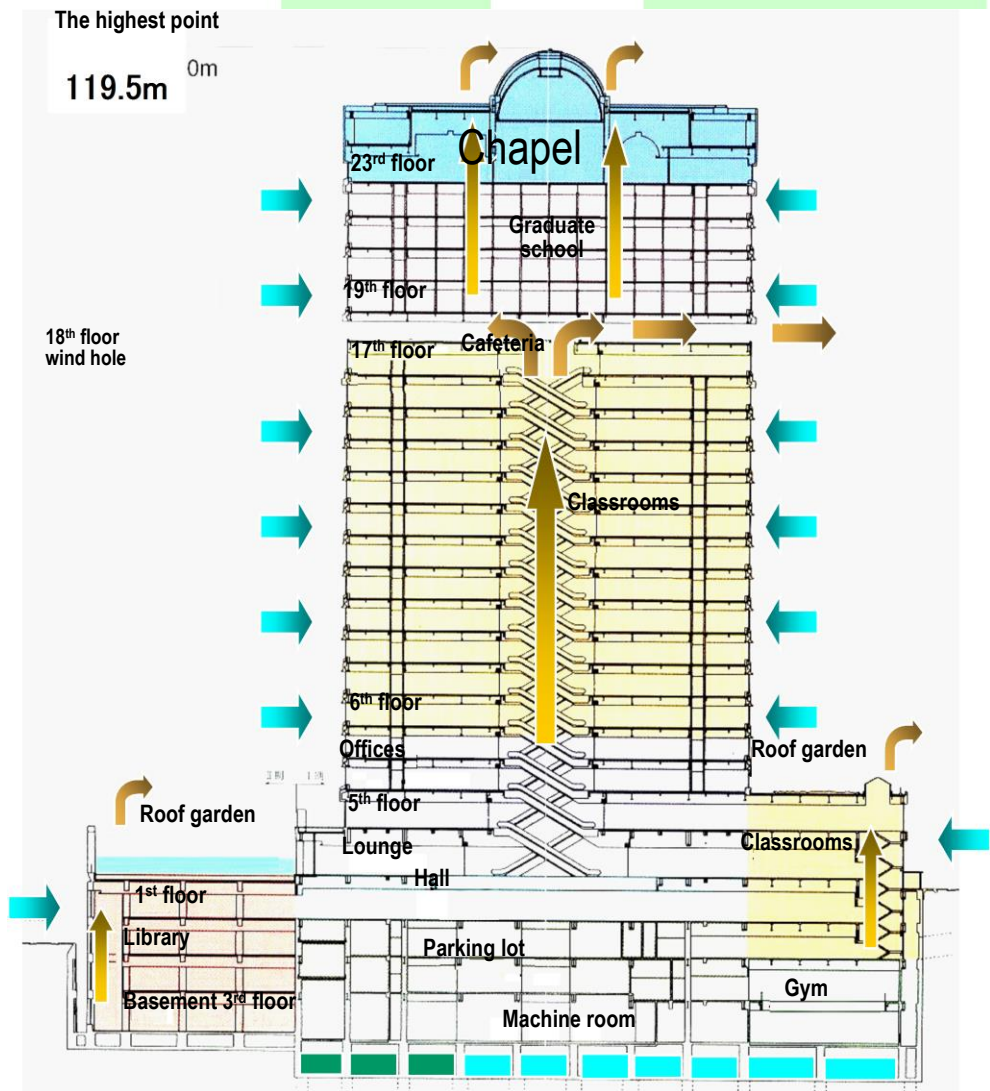

(7) Daylight Use Plus Lighting System

Classification of Measures			Low-carbon Measure	Applicability as per Type of Town			
Demand/ Supply	Major Classification	Minor Classification		I	II	III	IV
Demand	Building	Passive energy design & equipment	Daylight use, lighting system	H	H	H	H

Overview of Measures and Applicability

- The light from the window is limited in its reach, or no lighting is available if there is no window in the room. However, natural light reach the darker areas in the building through a light duct or light shelf. The illustrations given below show the system of a light duct using an aluminium mirror with 95% reflectivity of visible light for its interior in order to transport light from the light-collecting part to the light-releasing part.

Expected CO₂-Reducing Effect

- The system of using light ducts shown below is effective in cutting the annual lighting electricity consumption by approximately 65% over the conventional systems. It is noted that the Life Cycle (LC) CO₂ can be recovered in 7 to 8 years.

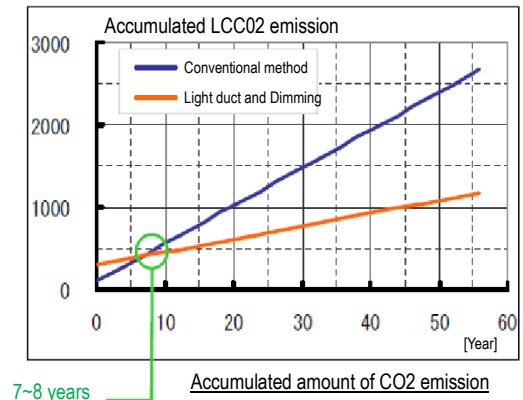
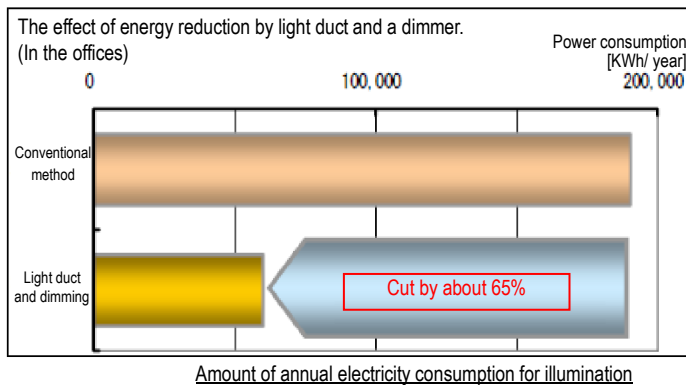

Examples of Application

- Japan Aerospace Exploration Agency (JAXA), Tsukuba Space Center (TSC), Toyota Motor Corporation Office Main Building

Schematic Diagram of the System, etc.

- Example of using a light duct in an office (JAXA, TSC)

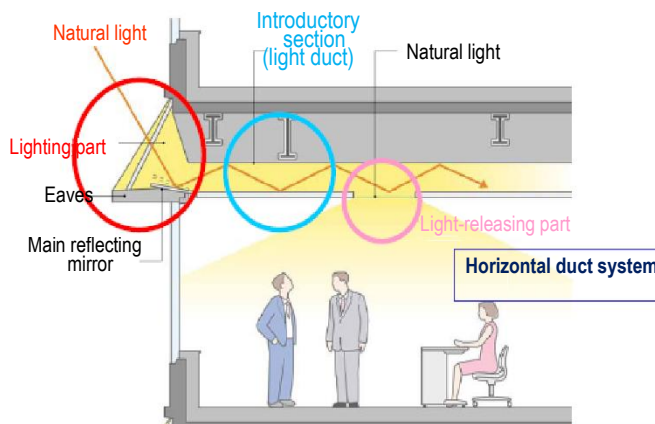

- Using example in the basement cafeteria (Main Building of a Car Company)

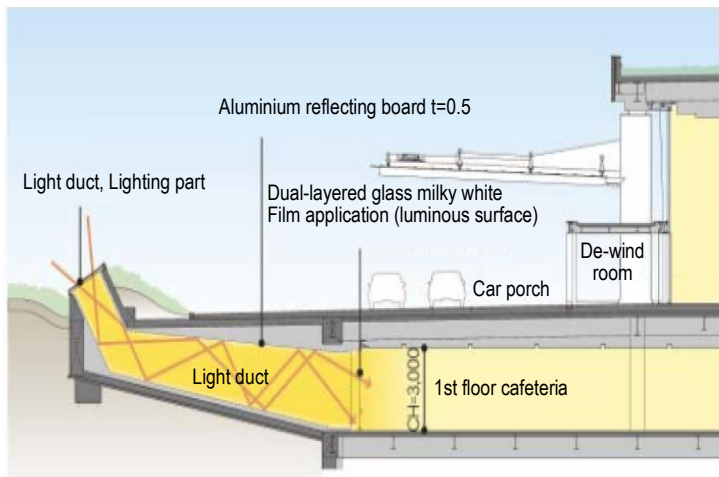

(8) Hybrid of Natural Ventilation Plus Air Conditioning

Classification of Measures			Low-carbon Measure	Applicability as per Type of Town			
Demand/ Supply	Major Classification	Minor Classification		I	II	III	IV
Demand	Building	Passive energy design & equipment	Hybrid of natural ventilation plus air conditioning	H	H	M	L

Overview of Measures and Applicability

- As an air conditioning facility system is incorporated into a building, it is a hybrid air conditioning system, which combines three types of air conditioning systems: air current feeding by the ceiling fan, floor blow-out air conditioning and natural ventilation.
- A ceiling fan generates gentle air current by stirring a large amount of wind with less electricity. It can realize a comfortable space at 28°C even in summer.
- Very high-efficiency ceiling fans are now becoming available: otherwise large numbers of fans can consume a surprisingly large amount of energy.

Cross-sectional view of building

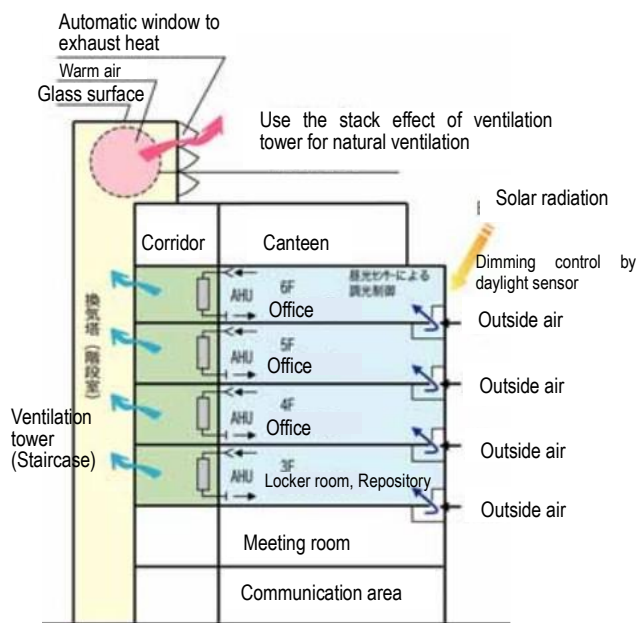

建物断面構成図

Expected CO₂-Reducing Effect

- Air conditioning load can be reduced by making natural ventilation the principal approach. Further CO₂ reduction can be expected by employing a human sensor or an automatic light dimmer for making the best of daytime light along with natural ventilation.

Examples of Application

- Sakai Gas Building, Osaka, Japan

Schematic Diagram of the System, etc.

- Sakai Gas Building



- Hybrid AC ventilation system using natural ventilation and ceiling fans

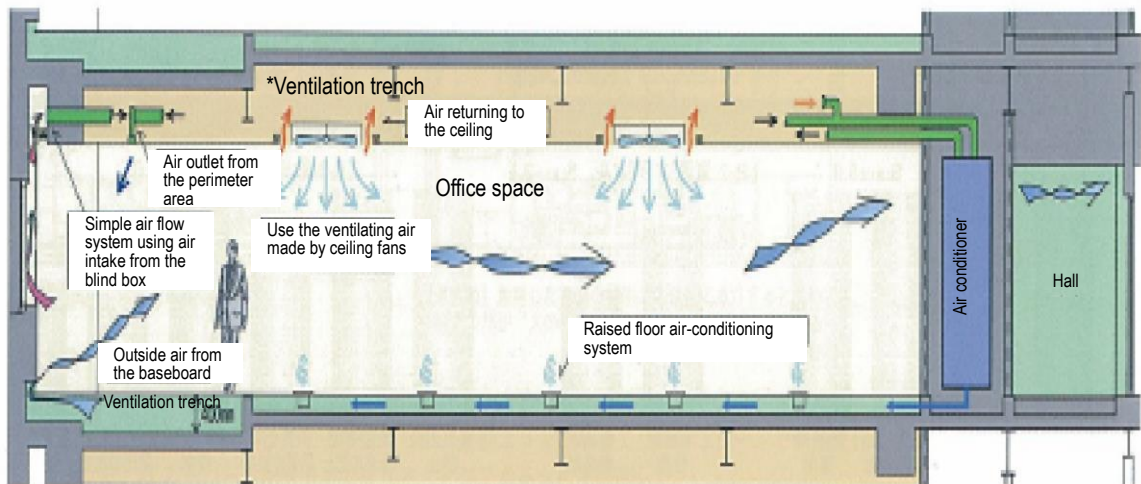

Source: CASBEE Studies on Actual Examples, JSBC, 2005

(9) High-efficient Heat or Cooling Source Plus Thermal Storage

Classification of Measures			Low-carbon Measure	Applicability as per Type of Town			
Demand/ Supply	Major Classification	Minor Classification		I	II	III	IV
Demand	Building	High-efficient Facility systems	High-efficient heat source plus heat storage	H	H	L	L

Overview of Measures and Applicability

- In an intensive and high-density district development on a large scale, a system of generating cold/hot water and steam at the central plant in the district and supplying them to individual buildings can contribute to the realisation of a low-carbon society by making the best of scale merit. However, it is important to minimise pumping energy and heat transfer to and from pipes to avoid undermining overall efficiency, especially in milder climates and where buildings are very energy efficient.
- The central plant in the district is divided into three categories:
 - 1) Electricity system: a system of generating cold and hot water by using turbo chillers, heat pump chillers, etc.
 - 2) Gas system: a system of generating cold water and steam by gas-absorption chillers or steam-absorption chillers using co-generated (CHP) steam exhaust heat.
 - 3) Electricity/gas combination system: a system of generating cold water, steam (hot water) by combining 1) electric heat source and 2) gas heat source.
- There are systems that combine one of the above-mentioned systems with untapped energies, such as river water, sewage heat and exhaust heat from waste incineration plants.

Expected CO₂-Reducing Effect

- The use of highly efficient district air conditioning and heating allows the reduction of air conditioning load, which is expected to reduce CO₂ emissions significantly.
- Furthermore, the reduction of energy cost can be expected by storing heat energy in thermal storage tanks with the use of night time electricity.

Examples of Application

- Harumi Island, Triton Square, Tokyo Japan, Nakanoshima Festival Tower, Osaka, Japan



Schematic Diagram of the System, etc.

● Harumi Island Area, Tokyo

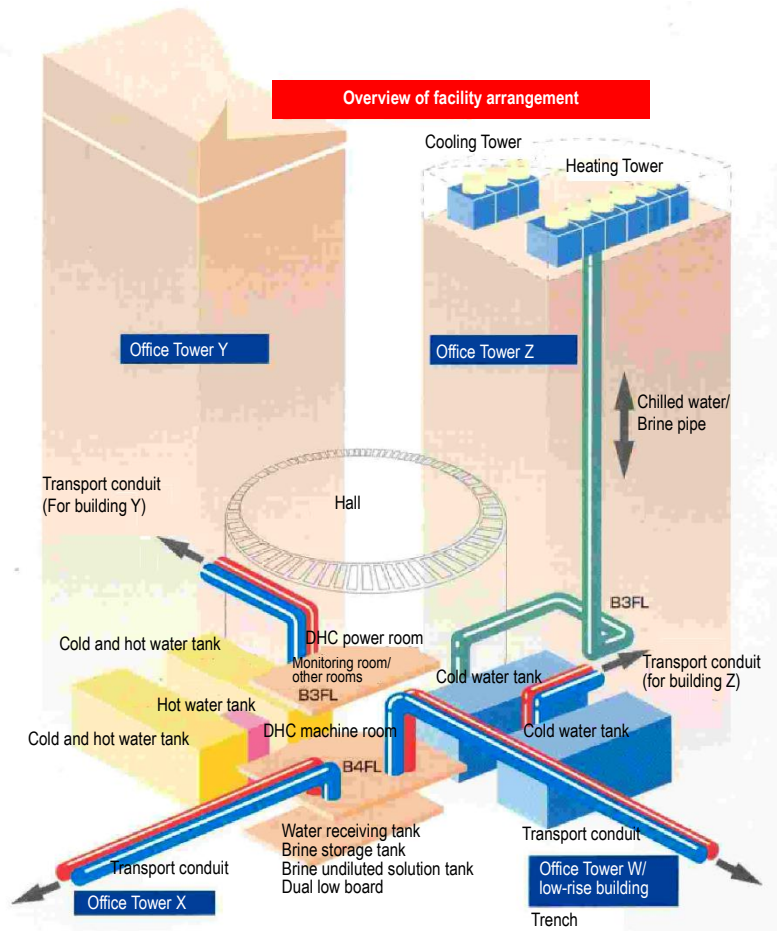
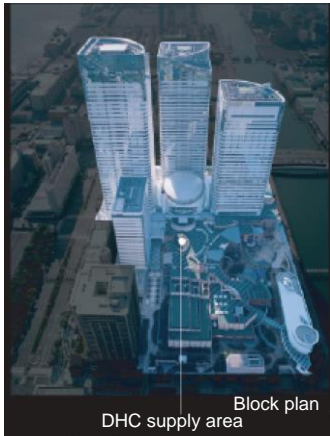

● Nakanoshima Festival Tower, Osaka

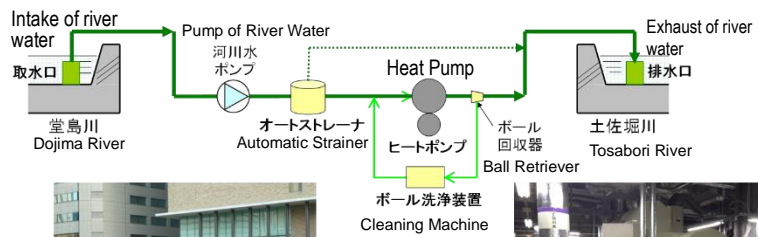

(10) Waste Heat from Sewage Treatment Plant

Classification of Measures			Low-carbon Measure	Applicability as per Type of Town			
Demand/ Supply	Major Classification	Minor Classification		I	II	III	IV
Supply	Untapped energy	Using waste heat	Using waste heat from sewage treatment plant	H	H	M	L
Overview of Measures and Applicability							
<ul style="list-style-type: none"> ● As sewage water temperature is lower in summer and higher in winter than the atmospheric temperature, it will contribute to improving energy efficiency both as a coolant of heat pumps used in heat source equipment for cooling and as heat-source water for heat pumps for heating/hot-water supply. ● Using sewage water heat means the reuse of city waste heat, and it may be regarded as a recycling-oriented city energy system. ● It is necessary to pay attention to the balance between the heat-supply source and the heat load from cooling/heating, as well as hot-water supply, considering such regional conditions as the amount of sewage water, daily/seasonal variations in temperature and interfusion of snow-melt water. In addition, as heat demand also varies in terms of time period and season, this variation should be reduced by installing heat storage tanks. ● Moreover, it requires corrosion-resistant treatment of the related equipment based on the water quality, as well as strainers for removing foreign matters contained in the sewage water. ● Considering the above, using waste heat system should be carefully designed in consideration of its capital expenditure (CAEX) and operating expenditure (OPEX). 							
Expected CO ₂ Reducing Effect							
<ul style="list-style-type: none"> ● It is expected that CO₂ will be reduced by means of improving energy efficiency in cooling/heating and hot-water supply in the relevant communities. 							
Examples of Application							
<ul style="list-style-type: none"> ● There are 12 records of application for sewage water temperature, such as applications inside and outside of wastewater treatment plants in Japan (as of Feb 2014). These applications for sewage water temperature are desirable, because it has high potential for energy. 							

Schematic Diagram of the System, etc.

- Image of temperature variation in sewage water and atmosphere

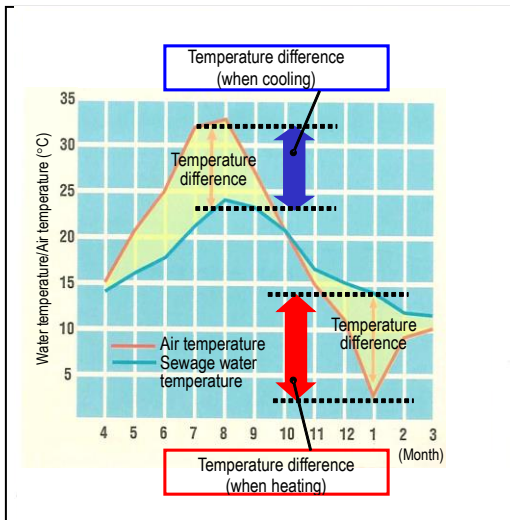

- Heat cycle using sewage water heat

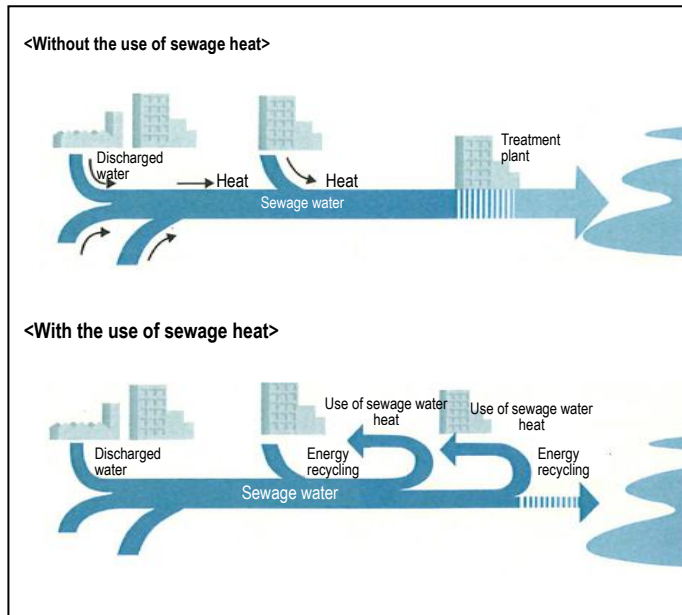

- Schematic diagram of a heat pump system using sewage water heat

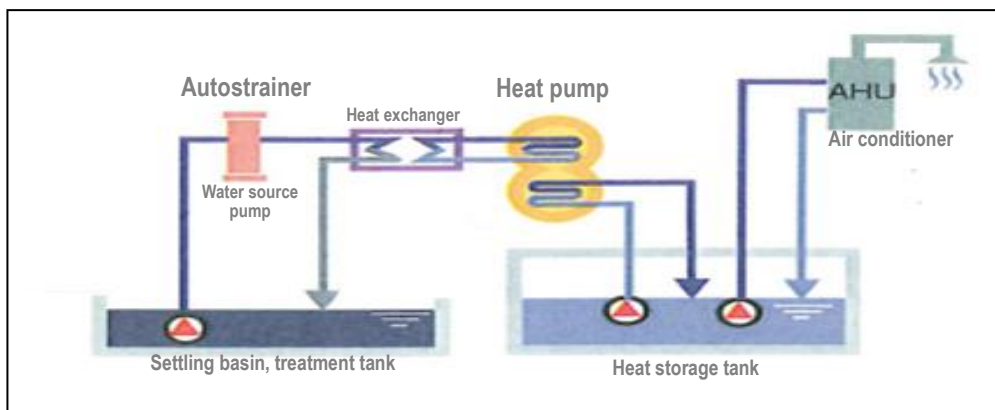

(11) Hydroelectric Power Generation

Classification of Measures			Low-carbon Measure	Applicability as per Type of Town			
Demand/ Supply	Major Classification	Minor Classification		I	II	III	IV
Supply	Renewable energy		Hydroelectric power generation (small and mid-scale)	L	L	L	M
Overview of Measures and Applicability							
<ul style="list-style-type: none"> ● Small and mid-scale hydroelectric power generation generally make use of water without storing it. Depending on the method of water use and the structure for gaining a head of water, several forms exist. ● Small and mid-scale hydro power generation carries a heavy burden of electrical equipment costs. It takes a greater share of the total construction cost in comparison to large-scale hydroelectric power generation. ● In addition to the systems utilising nearby rivers, the cases can be assumed where hydroelectric power generation systems are installed as a form of agricultural drainage facility in farming villages. ● Small hydroelectric power generation can also take advantage of existing infrastructure, such as water-supply dams or water-supply pipes that are running downhill. ● 'Pumped hydro' where water is pumped uphill to a storage dam when excess cheap energy is available, then generates electricity when it is needed, can be a low cost storage option. Instead of a lower dam, the sea or a lake can be used to reduce costs ● Low-cost technologies can reduce the capital costs of small hydroelectric power generation. For example, in Palmerston North, New Zealand, a pump that 'runs backwards' to generate electricity was installed on the local water-supply dam. Although this is about 30% less efficient than a purpose-designed hydroelectric unit, it was much cheaper to install. 							
Expected CO₂-Reducing Effect							
<ul style="list-style-type: none"> ● It is expected that CO₂ will be reduced by means of increasing electricity generation from renewable sources. Pumped storage allows renewable energy to contribute a larger proportion of electricity demand by providing hydroelectric power generation at times when other renewable sources are not available and by storing excess renewable energy. 							
Examples of Application							
<ul style="list-style-type: none"> ● Palmerston, North New Zealand (Ralph Sims) – low cost hydroelectric unit installed on local water-supply dam. ● Melbourne Water (Australia) has installed mini-hydroelectric units in water-supply pipes between dams and consumers. ● In some developing countries, farmers use very small 'run of river' hydroelectric generators driven by water flow rather than vertical head that can be easily moved to avoid floods. 							

Schematic Diagram of the System, etc.

● Run-of-river type power station

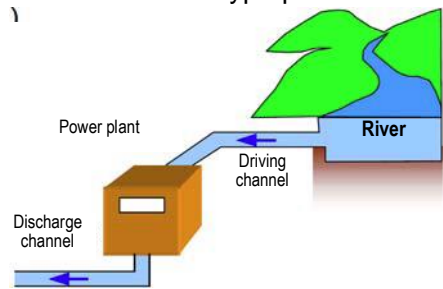

● Reservoir type power station

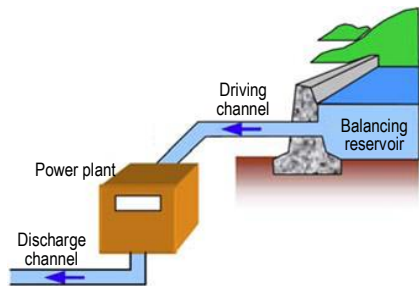

Source: NEDO White Paper on Renewable Energy Technologies

(12) Waste Heat from Incineration Plants

Classification of Measures			Low-carbon Measure	Applicability as per Type of Town			
Demand/ Supply	Major Classification	Minor Classification		I	II	III	IV
Supply	Untapped energy		Using waste heat from incineration plants	H	H	M	M
Overview of Measures and Applicability							
<ul style="list-style-type: none"> ● The exhaust gas from refuse incineration at garbage disposal facilities has a high temperature, and it can be utilised for power generation and as an infrastructure for heat supply. ● As garbage disposal facilities are often built away from residential areas, it is necessary to develop a plan that facilitates heat use on the basis of garbage disposal facilities as an infrastructure for energy supply. ● Local community concerns about air pollution can undermine support for this technology unless implementation is carefully managed. In many developing countries, this can significantly improve local air quality, odours and health relative to existing waste management practices. 							
Expected CO₂-Reducing Effect							
<ul style="list-style-type: none"> ● It is expected that CO₂ will be reduced by means of improving energy efficiency in each region through power generation from unused energy and utilisation of surplus waste heat. ● Note that where plastic, tyres and other wastes that do not decay in landfills, net greenhouse gas emissions relative to landfill may be small coming from materials produced from the burning of fossil fuels. However, where it replaces open burning of waste or simple incineration, it provides zero-emission energy and significant environmental and health benefits. 							
Examples of Application							
<ul style="list-style-type: none"> ● In case of Yokohama City The heat generated during the incineration process is converted to electric power by steam turbines; the power generated is used for operating various plant components, such as appliances, air-conditioning and heat-utilising facilities (heated swimming pools and welfare centres for the elderly). In addition to using the electricity generated within the plants, the city also supplies it to other heat-utilising facilities, as well as the Northern Area Water Recycling Center II and the Northern and Southern Area Sewerage Centers. The city also sells electricity to power companies. The amount sold in 2011 was equivalent to the amount approximately 71,000 households (equivalent to the whole of Isogo-ku) use over the course of one year. 							

Schematic Diagram of the System, etc.

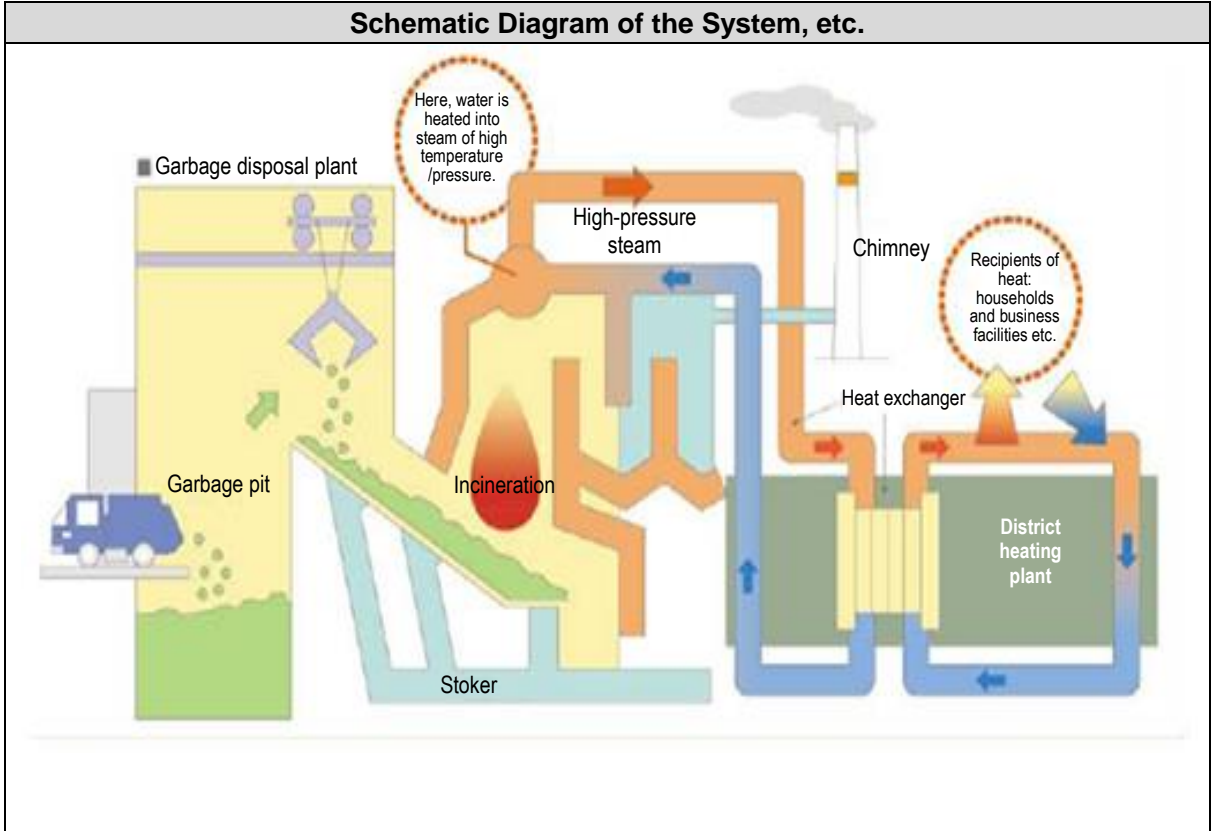

(13) Solar Power Generation

Classification of Measures			Low-carbon Measure	Applicability as per Type of Town			
Demand/ Supply	Major Classification	Minor Classification		I	II	III	IV
Supply	Renewable energy		Solar power generation	M	M	M	M
Overview of Measures and Applicability							
<ul style="list-style-type: none"> ● In principle, the cost and efficiency of renewable energy power generation depend on such factors as the climate conditions and administrative support measures in the relevant regions. ● Solar photovoltaic power generation is a collective term for technologies using semiconductors to convert light energy into electricity. Semiconductors (solar cells) can be classified into types using multi-crystalline silicon, thin film silicon, chemical compound/organic, etc. Solar power generation ranges from large-scale power generation systems to mid- and small-sized power generation systems for industry and household use. ● Compared with other renewable energy power generation systems, this system has an advantage in terms of the ease of installation and maintenance and no conditions for installation. On the other hand, it has the highest introduction cost per unit of electricity generated. However, onsite PV competes with retail electricity prices, which are much higher than wholesale electricity prices, so it can often be cost-competitive where electricity grids exist. Costs are falling rapidly. In areas without access to a reliable electricity grid, it can be a low-cost energy supply option. However, for reliable supply, it may require energy storage and smart demand management. For many small applications, where the installation of power cables can be avoided, it can also be attractive, e.g. for lighting on bicycle tracks, traffic lights, signs, street lights, irrigation and pumps. ● A certain amount of energy output can be expected where solar insolation is obtained, and this system has a wider applicability than solar heat power generation or wind power generation systems. 							
Expected CO ₂ Reducing Effect							
<ul style="list-style-type: none"> ● It is expected that CO₂ will be reduced by replacing fossil fuel use with solar electricity. 							
Examples of Application							
<ul style="list-style-type: none"> ● Example of Solar Power Generation (Ground Mounted) Mito Newtown Mega Solar Park, Japan Renewable Energy Co., Ltd Location: Mito City, Ibaraki Prefecture, Japan Power Generation Output: 39,210kW 							



- City of San Diego, California, USA Solar Energy Implementation Plan
<http://www.sandiego.gov/environmental-services/pdf/sustainable/SolarImplementationPlan-May2010.pdf>
- Santiago, Chile – the precinct the APEC study group visited had solar lighting for a bicycle track.

Schematic Diagram of the System etc.

- Mid-sized power generation system

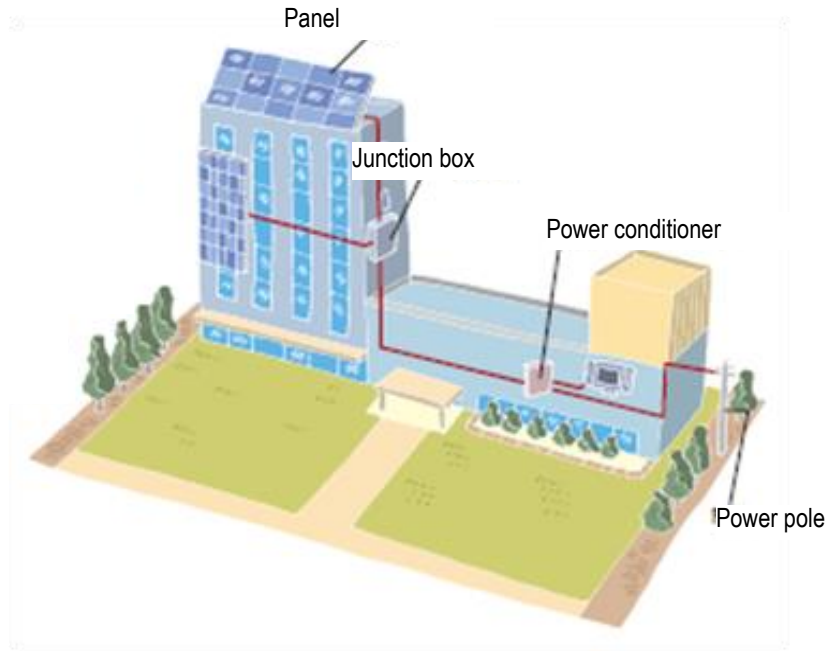

- Small-sized power generation system

The general composition of a solar photovoltaic power generation system (for a single-family residence)

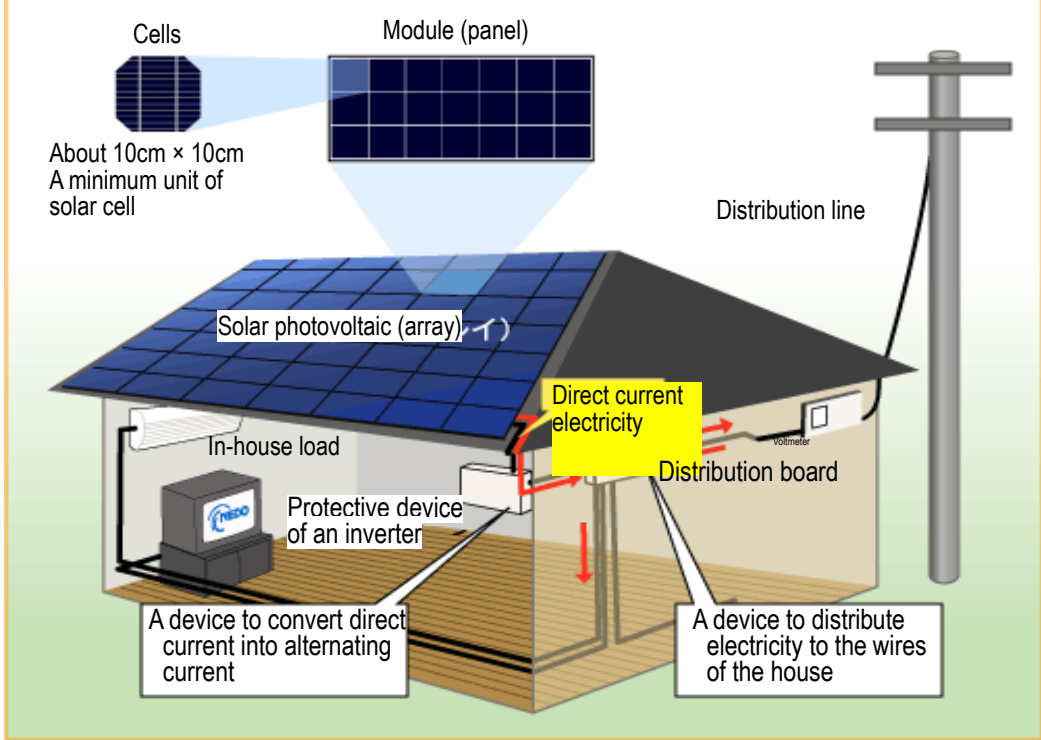

(14) Solar Heating & Cooling

Classification of Measures			Low-carbon Measure	Applicability as per Type of Town			
Demand/ Supply	Major Classification	Minor Classification		I	II	III	IV
Supply	Renewable energy		Using solar heat	M	M	M	M
Overview of Measures and Applicability							
<ul style="list-style-type: none"> ● Utilising the natural energy of solar heat for hot-water supply and cooling/ heating makes it possible to promote energy saving and CO₂ reduction in buildings. ● Solar heat can be utilised for household and commercial use. ● The improving performance of heat pumps combined with declining cost of PV means that solar thermal system costs should be carefully compared with alternatives such as PV-powered heat pumps. 							
Expected CO₂-Reducing Effect							
<ul style="list-style-type: none"> ● Annual gas consumption and CO₂ emissions can be reduced by about 30% by using solar heat (Based on an average household of three family members in a housing complex; a trial calculation for a solar heat system with a heat collection area of 3m², installed facing south). 							
Examples of Application							
<ul style="list-style-type: none"> ● A housing complex in Kawasaki, Japan ● An office building in Kumagaya, Japan ● Solar thermal cooling system at a hospital in Echuca, Victoria, Australia 							

Schematic Diagram of the System, etc.

- Combination of solar heat and gas hot-water heater systems (for household use)

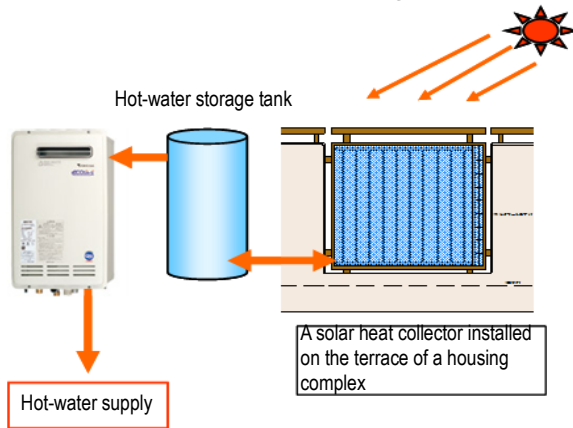

- Use of solar heat for gas air-conditioning (for buildings)

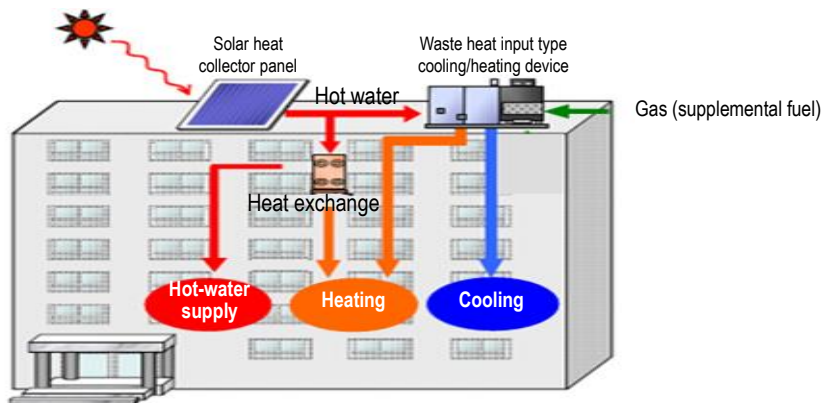

(15) Biomass Power Generation

Classification of Measures			Low-carbon Measure	Applicability as per Type of Town			
Demand/ Supply	Major Classification	Minor Classification		I	II	III	IV
Supply	Renewable energy	Biomass power generation	Biogas injection into city gas combustion	L	L	L/M	M
Overview of Measures and Applicability							
<ul style="list-style-type: none"> ● Biomass power generation is a collective term for power generation technologies using biomasses (animal/plant resources and organic wastes from these resources) for direct incineration, heat decomposition, fermentation, etc. The form of biomass can be roughly classified into unused resources (forest resources, agricultural residues, etc.), waste resources (building materials, paper manufacturing materials, livestock manure, food residues, etc.) and production resources (pasture grass, water plant, vegetable oil, etc.). ● Suitable locations vary with the type of resources, because biomass needs stable supply. Where seasonal sources exist, storage of fuel or alternative biomass sources may be needed to ensure reliable generation. ● Excessive biogas generated from sewage sludge or food waste, etc. is put to an effective onsite use as the fuel for power generation or automobiles. If generated biogas or electricity still remains after onsite use, it would be possible to supply energy (biogas, co-generation power) to the outside. ● Not only these measures contribute to energy conservation and CO₂ reduction, but they help make the best use of and recycle the local biogas resources, such as sewage sludge or kitchen garbage, for a long-term and in a stable manner. 							
Expected CO ₂ -Reducing Effect							
<ul style="list-style-type: none"> ● CO₂ will be reduced through renewable power generation. ● Where biomass energy use avoids anaerobic decay and leakage of very greenhouse-active methane into the atmosphere, there are large additional emission benefits from avoiding the leakage of methane. ● (Example) Injection of biogas into city gas conduits: Approx. 1,830 tons/year ● (outlined in below: case example of Tokyo metropolitan area) 							
Examples of Application							
<ul style="list-style-type: none"> ● Example of Biomass Power Generation (recycling of food residue) Recycling plant of Shochu (Japanese Spirit) lees, Kirishima Shuzo, Co., Ltd. Location: Miyakonojo City, Miyazaki Prefecture, Japan Processing Objects: Shochu lees 800t/day, Sweet potato pulp 10t/day, Factory waste water 10t/day, Dehydrated cake 60t/day Power Generation Output: 1,905kW Type of Power Generation: Gas engine 							



- Biogas generation: Tokyo metropolitan area, Yokohama City, etc. (About 30 sewage treatment facilities, etc.), Japan
- Biogas automobiles: Kobe City and Ueda City, Japan
- Injection of biogas into city gas conduits: Kobe City and Tokyo metropolitan area, Japan

Schematic Diagram of the System etc.

- Biomass power generation system (NEDO)

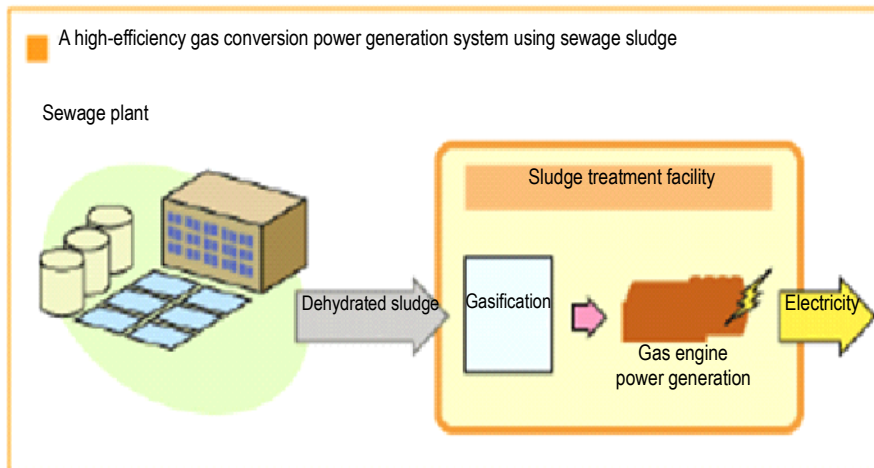

- Melbourne Water (Australia) captures methane from sewage ponds at one site for electricity generation. At another site it uses sewage in a biodigester to provide heat energy for the sewage plant.
- Example of onsite biogas use (Beer plant)

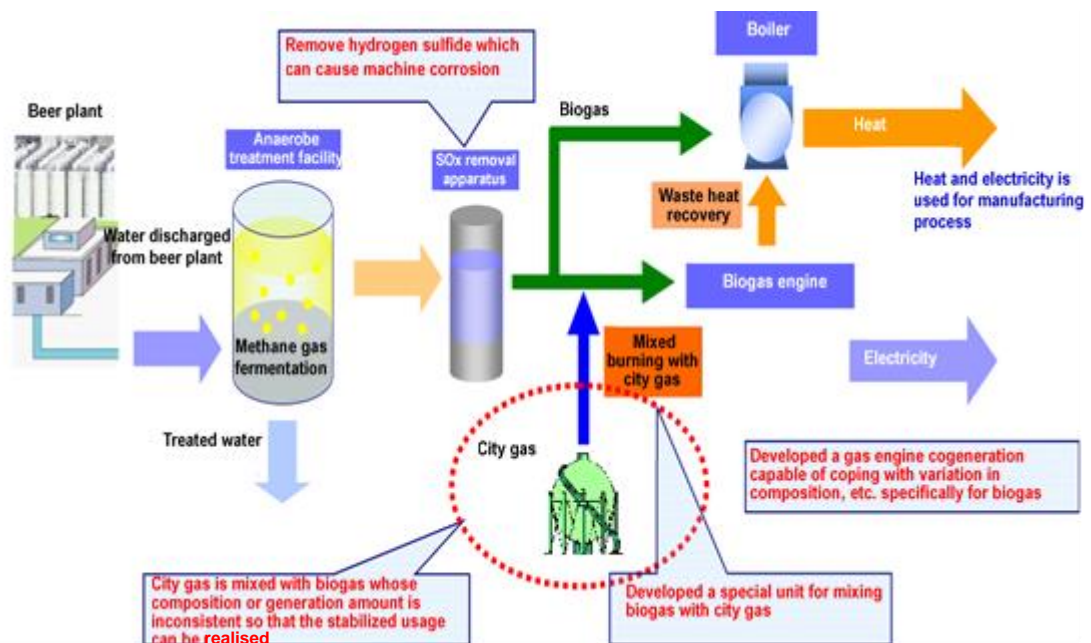

- Injection of biogas derived from food residues (Tokyo metropolitan area)

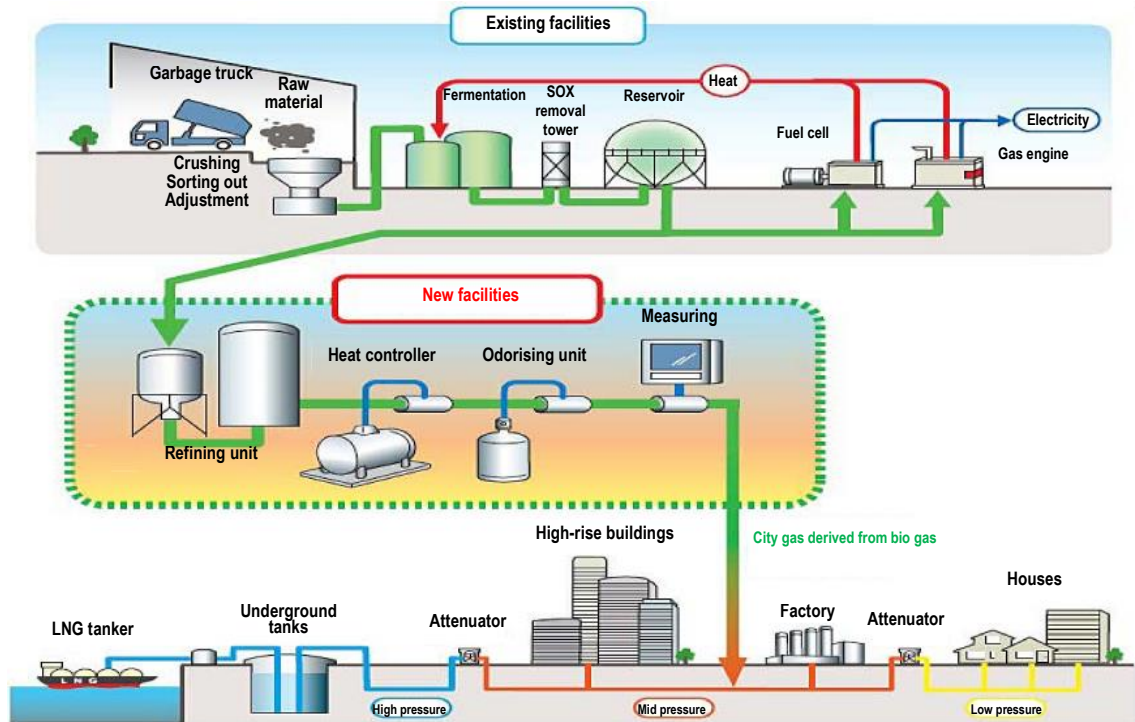

(16) Geothermal Power Generation

Classification of Measures			Low-carbon Measure	Applicability as per Type of Town			
Demand/ Supply	Major Classification	Minor Classification		I	II	III	IV
Supply	Renewable energy		Geo-thermal power generation	X	L	L	M
Overview of Measures and Applicability							
<ul style="list-style-type: none"> ● Geo-thermal power generation is a collective term for power generation using geo-thermal energy. There are two different systems to convert thermal energy into electrical energy via steam turbines: a flash and binary system. ● Compared with other renewable energy generation systems, this system has an advantage in terms of energy stability, but it is necessary to take account of environmental risks (air pollution caused by releases of hydrogen sulphide, etc.). ● The regions where this system can be applied are limited to those that can meet the criteria, namely, a specified amount of geo-thermal energy resources existing underground that can be developed at a reasonable cost. 							
Expected CO ₂ -Reducing Effect							
<ul style="list-style-type: none"> ● It is expected that CO₂ will be reduced by means of using clean energy for electricity/heat generation in the relevant communities. 							
Examples of Application							
<ul style="list-style-type: none"> ● The Lahendong geothermal power plant, which is located 30km south of Manado, in North Sulawesi, Indonesia, supplies almost 40% of the electricity demand in Manado. It comprises four 20MW units utilising a flush system. At present, the demonstration project (550kW) is now ongoing at Lahendong in order to show the viability of binary technology, which utilises lower-temperature liquid phase from a high-temperature wet stream. ● Indonesia, Philippines, New Zealand and USA are the top four geothermal electricity producers. ● In areas off grids, where expensive diesel fuel is used for generation, lower-temperature geothermal heat (e.g. from hot aquifers providing water supply) can be used to produce electricity using the Organic Rankine Cycle and other emerging technologies. These units can also use waste heat from a diesel generator to produce electricity. 							

Schematic Diagram of the System etc.

- Geo-thermal power generation system (A binary system (upper) vs. a flash system (lower) – ‘White Paper on Renewable Energy’, NEDO)

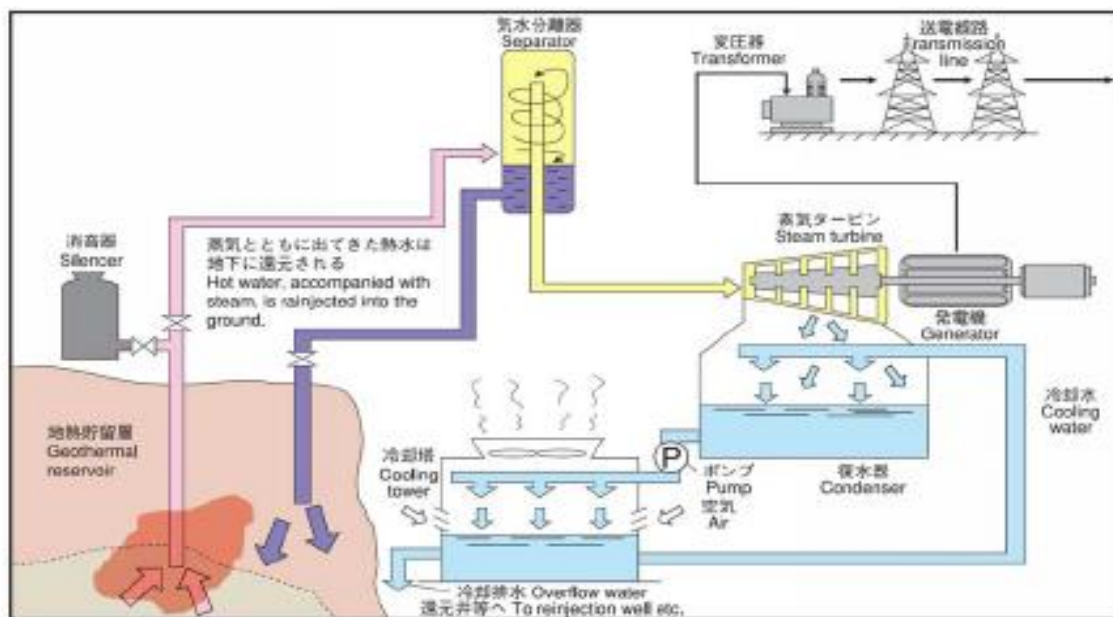
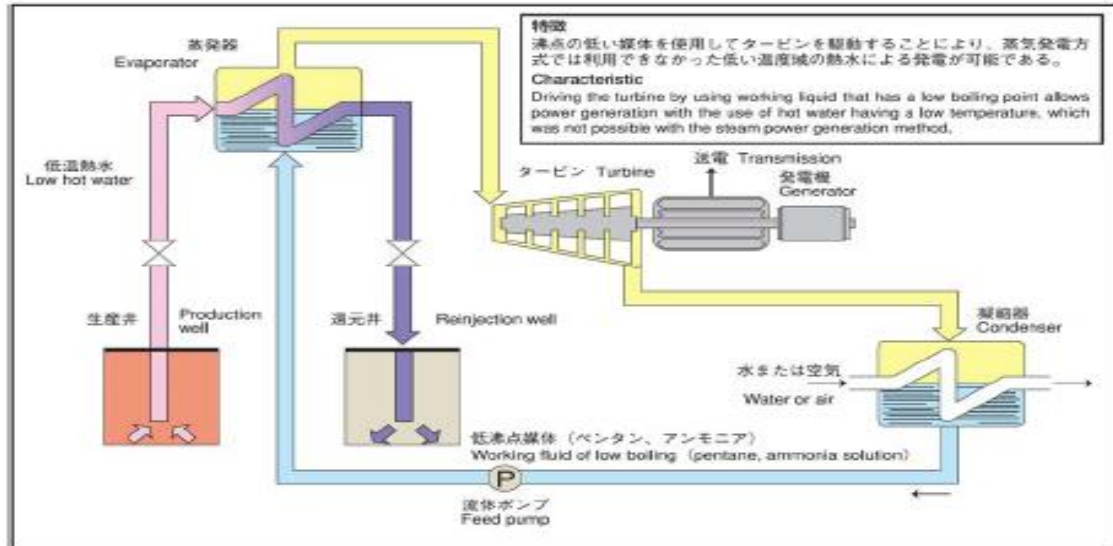

(17) Wind Power Generation

Classification of Measures			Low-carbon Measure	Applicability as per Type of Town			
Demand/ Supply	Major Classification	Minor Classification		I	II	III	IV
Supply	Renewable energy		Wind power generation	L	L	L	M
Overview of Measures and Applicability							
<ul style="list-style-type: none"> ● Wind power generation is a collective term for technologies used to generate electricity by means of capturing wind energy with rotor blades and transferring the rotational energy to generators. This power generating system has various types depending on the structure of blades and size, but it can be roughly classified into large-scale wind power generation linked to the grid and mid- or small-scale wind power generation intended to be used within each region. ● Compared with other renewable energy generation systems, this system has an advantage in terms of low introduction cost per unit of electricity generated. On the other hand, it has a disadvantage of low energy efficiency in case of limited geographical conditions (dependent on wind conditions) or small-scale power generation. ● As wind energy (P) increases in proportion to the cube of wind velocity (V) ($P = 1/2 \rho A v^3$), it is highly probable that this system can be applied in regions with favourable wind conditions. Local terrain features can concentrate wind, while small wind turbines can be installed on tall existing structures (subject to turbulence issues) ● While offshore wind generation is still expensive, costs are declining and the wind resources are often better. 							
Expected CO ₂ Reducing Effect							
<ul style="list-style-type: none"> ● It is expected that CO₂ will be reduced by means of using clean energy in electricity generation in the relevant communities. 							
Examples of Application							
<ul style="list-style-type: none"> ● Example of Onshore Wind Power Generation Oga Wind Farm, Summit Energy Corporation Location: Oga City, Akita Prefecture, Japan Power Generation Output: 28,800kW 							



- Example of Offshore Wind Power Generation

Joint demonstration study conducted by New Energy and Industrial Technology Development Organization (NEDO) and Tokyo Electric Power Company

Location: 3.1 km off the coast of Choshi, Chiba Prefecture, Japan

Power Generation Output: 2,400kW

Observation Tower: 100m above sea level



Schematic Diagram of the System, etc.

- Wind power generation system
(NEDO – 'White Paper on Renewable Energy')

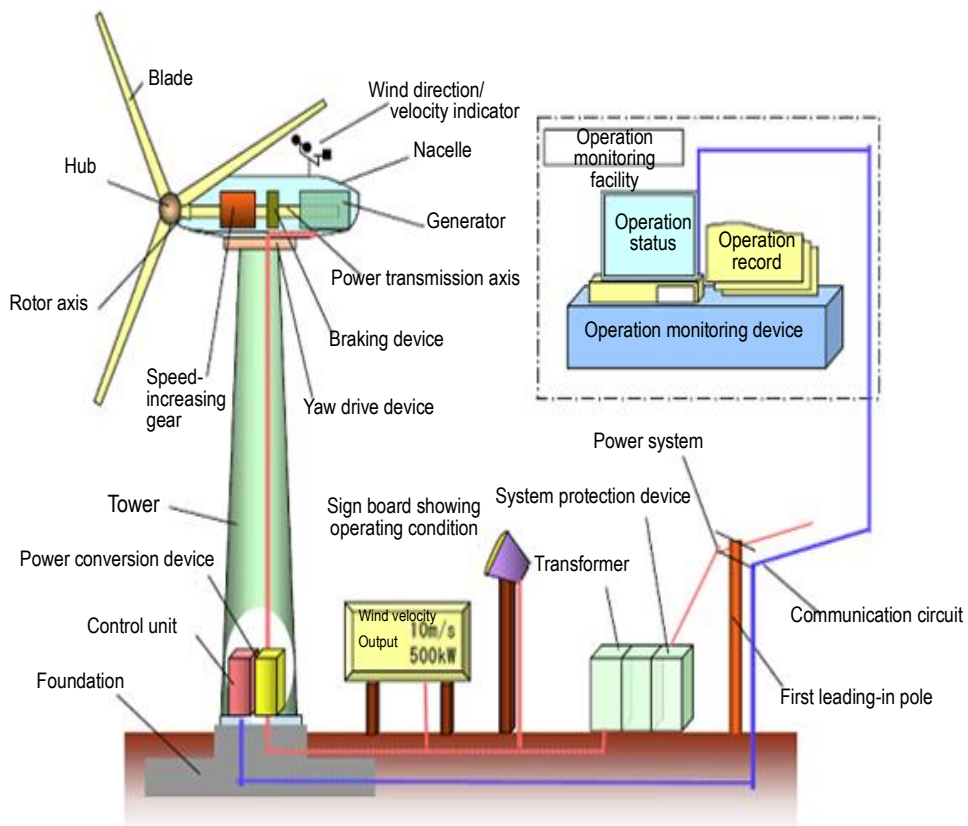

(18) Fuel Cell

Classification of Measures			Low-carbon Measure	Applicability as per Type of Town			
Demand/Supply	Major Classification	Minor Classification		I	II	III	IV
Demand	Buildings	Equipment installed at facilities	Fuel cell	H	H	M	M
Overview of Measures and Applicability							
<ul style="list-style-type: none"> ● Electricity is generated by hydrogen taken out of natural gas, methanol, etc. and oxygen from air, while the heat concurrently generated is collected as steam or hot water. This is a highly efficient power generation, because electricity is generated directly from hydrogen using an electrochemical reaction. ● Fuel cells can be used for various uses and systems with different scales (0.75kW~200kW). ● It also contributes to the reduction of peak time power consumption and the improvement of energy security. 							
Expected CO₂ Reducing Effect							
<ul style="list-style-type: none"> ● Because power is generated as hydrogen and oxygen react with each other, water is the only substance that is formed. Although carbon dioxide (CO₂) is generated while hydrogen is being produced, the generated amount is less while using the identical volume of electricity and heat owing to high overall efficiency. ● For an ordinary household of four people, CO₂ can be reduced by approximately 40% per year compared to the conventional system (thermal power generation and boiler). ● In the long term, fuel cells will be able to achieve zero emissions by using renewable energy from generated hydrogen. Technology development in this area is occurring rapidly, as many see hydrogen as a key transportable form of renewable energy, while the efficiency of hydrogen production from renewable energy is also improving. 							

Examples of Application

- For buildings, automobiles, personal computers, etc.

Fuel-cell car

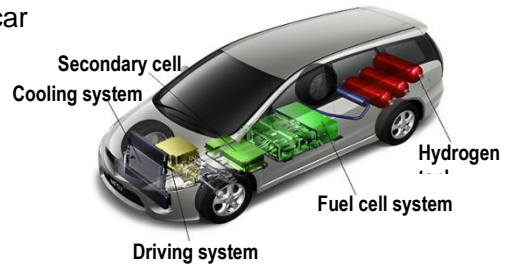

- Fuel cells for residences



Schematic Diagram of the System, etc.

- Fuel cell system

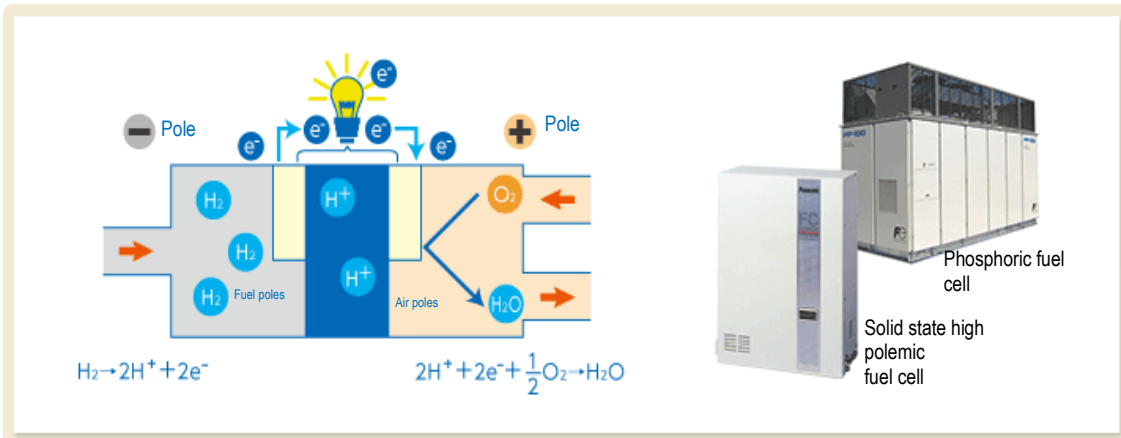

- Power generation with fuel cell

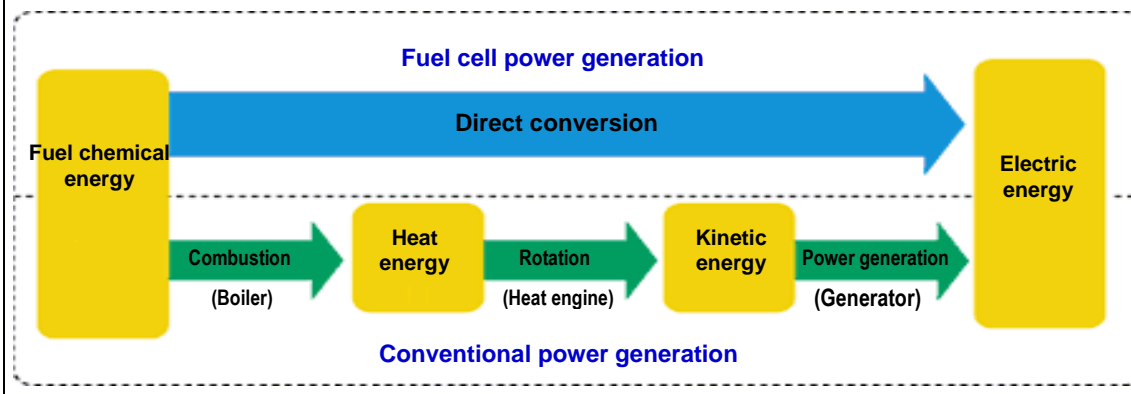

(19) Transportation (Establishment of Public Transportation Network)

Classification of Measures			Low-carbon Measure	Applicability as per Type of Town			
Demand/ Supply	Major Classification	Minor Classification		I	II	III	IV
Demand	Transportation system	Public transportation systems	Well developed public transportation network	M	M	M	X
Overview of Measures and Applicability							
<ul style="list-style-type: none"> There are a variety of public transportation systems in cities. Typical transportation systems are subways, LRT (Light Rail Transport), BRT (Bus Rapid Transport) and route buses. By establishing a public transportation network that combines optimal public transportation systems based on the city size and the demand for transportation, low-carbon urban life and sustainable cities must be realised through the use of public transportation with fewer CO₂ emissions. There is evidence that early provision of light or heavy rail or metro services encourages urban development along the routes that support lower dependence on cars. The perception of permanence of investment in PT infrastructure is important, as it reduces perceptions of investment risk for developers in comparison with provision of bus services, which can easily be removed or redirected by future policy decisions. Provision to securely store and carry bicycles, wheelchairs and mobility scooters can be important ways of increasing utilisation of PT systems. Emerging small personal electric scooters, skateboards and other easily carried local transport personal vehicles will also enhance the viability of PT systems for a wider catchment of users. 							
Expected CO₂-Reducing Effect							
<ul style="list-style-type: none"> As people use public transportation systems, which emit less CO₂ than automobiles, its development contributes to curbing the amount of CO₂ emissions in cities. Electrified PT is easily shifted to renewable energy, simply by producing renewable electricity for the grid that serves it. Conversion of diesel or gas-fuelled PT is more difficult, although hybrid and electric buses are emerging. 							
Examples of Application							
<ul style="list-style-type: none"> There are a number of examples of well-developed public transportation networks in cities in the APEC region. 							

Schematic Diagram of the System, etc.

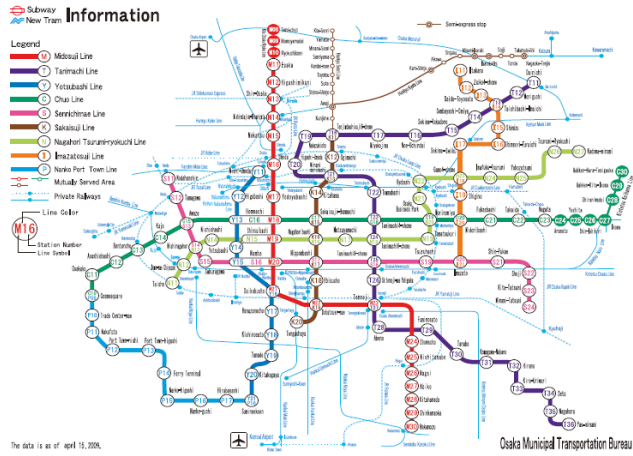

Subway network of Osaka City, Japan

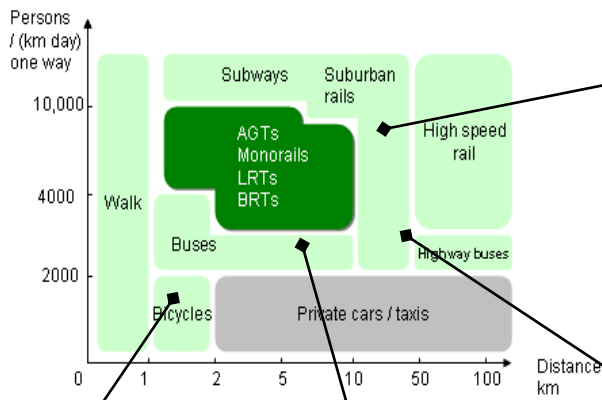

Fig.1 Comparison of urban transportations in capacity
Japan Railway & Transport Review 1998

UMRT, Subway



LRT



BUS



BRT



(20) Local Transportation System (Bus, LRT, etc.)

Classification of Measures			Low-carbon Measure	Applicability as per Type of Town			
Demand/Supply	Major Classification	Minor Classification		I	II	III	IV
Demand	Transportation system	Public transportation system (Bus, LRT)	Intra-district transportation system	H	H	H	L
Overview of Measures and Applicability							
<ul style="list-style-type: none"> ● The LRT, BRT and buses are the public transportation systems that offer services in a part of city area, such as the CBD (Central Business District). The establishment of those systems would serve to improve convenience for the people who travel in the area. ● Although the carrying capacity is smaller than that of mass transportation systems, such as subways, they can be established with less cost and the distance between stops can be shorter than that in subways. ● Note points made previously about complementing these PT modes with supplementary personal transport to expand the catchment area of potential users. 							
Expected CO ₂ -Reducing Effect							
<ul style="list-style-type: none"> ● As traveling by local public transportation becomes more convenient, people begin to use public transportation systems that emit less CO₂ than cars. Therefore, these measures are effective in curbing the amount of CO₂ emissions from inside cities. 							

Examples of Application

- Bus Service Route & Vehicles in Tokyo CBD (Marunouchi)

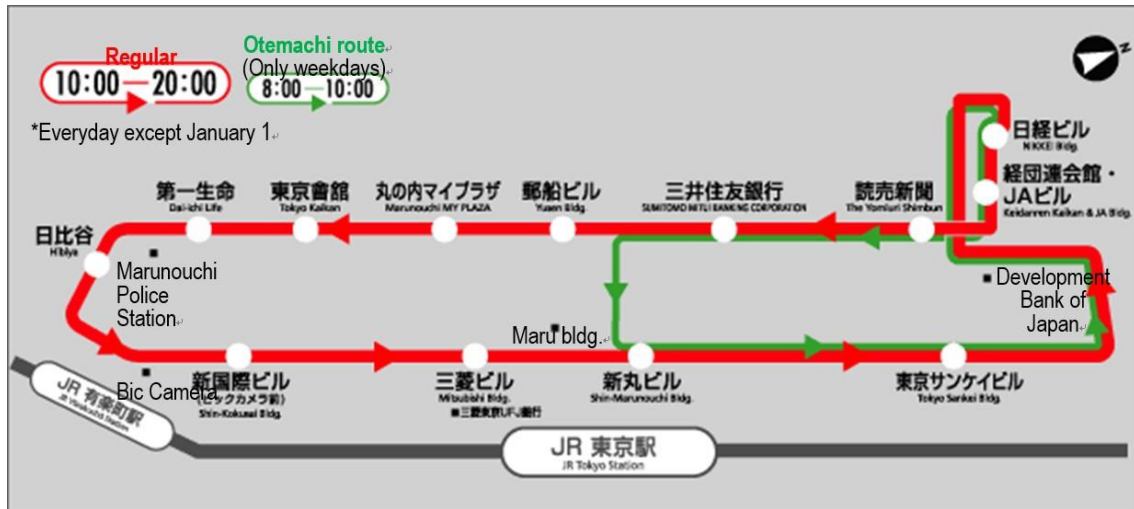

<http://www.hinomaru.co.jp/metrolink/marunouchi/index.html>



- Light Rail System (Linimo) in Nagoya, Japan

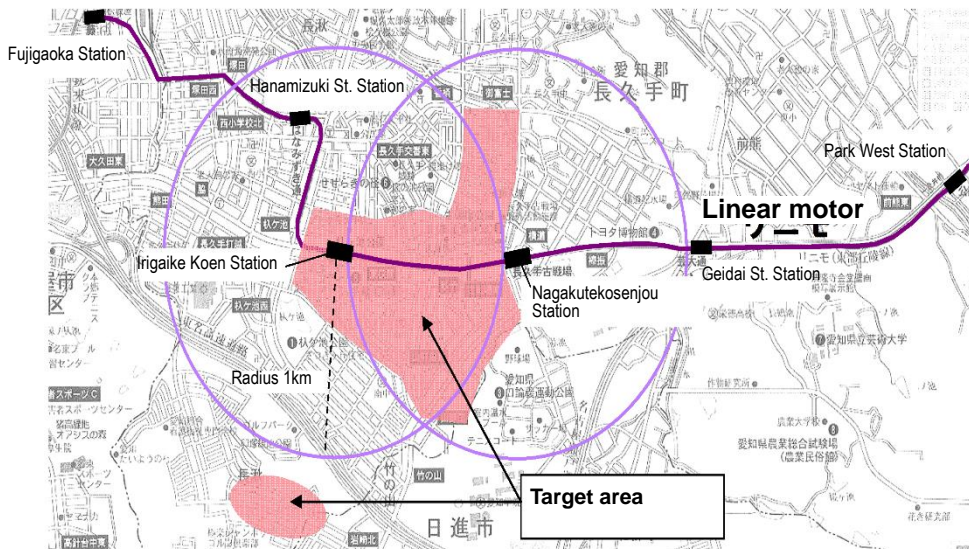

<http://www.linimo.jp/sonota/index.html#02>



(21) Electrically Driven Vehicle

Classification of Measures			Low-carbon Measure	Applicability as per Type of Town			
Demand/ Supply	Major Classification	Minor Classification		I	II	III	IV
Demand	Transportation system	Vehicles	Electrically driven vehicle (EV, HEV, PHV, FCV)	M	M	M	M
Overview of Measures and Applicability							
<ul style="list-style-type: none"> The wide use of electrically driven vehicles will be promoted through improving the environment for their usage, such as installing chargers and enhancing public relations activity for the electrically driven vehicle environmental performance over conventional cars. 							
Expected CO₂-Reducing Effect							
<ul style="list-style-type: none"> Electrically driven vehicles do not run on fossil fuels, such as gasoline, unlike existing automobiles. They are also more efficient, and therefore, they serve to reduce the amount of CO₂ emissions and local air pollution from traffic. A wide variety of electric vehicles, including e-bikes, mobility scooters for the disabled and elderly, electric skateboards and Segways, are emerging. These allow young, old and those without driving licenses to be independently mobile. This reduces the number of 'chauffeuring' trips in cars. For example, in Sydney Australia in 2011, 22% of weekday car trips were to take a passenger to a destination to which the driver did not want to go. 							

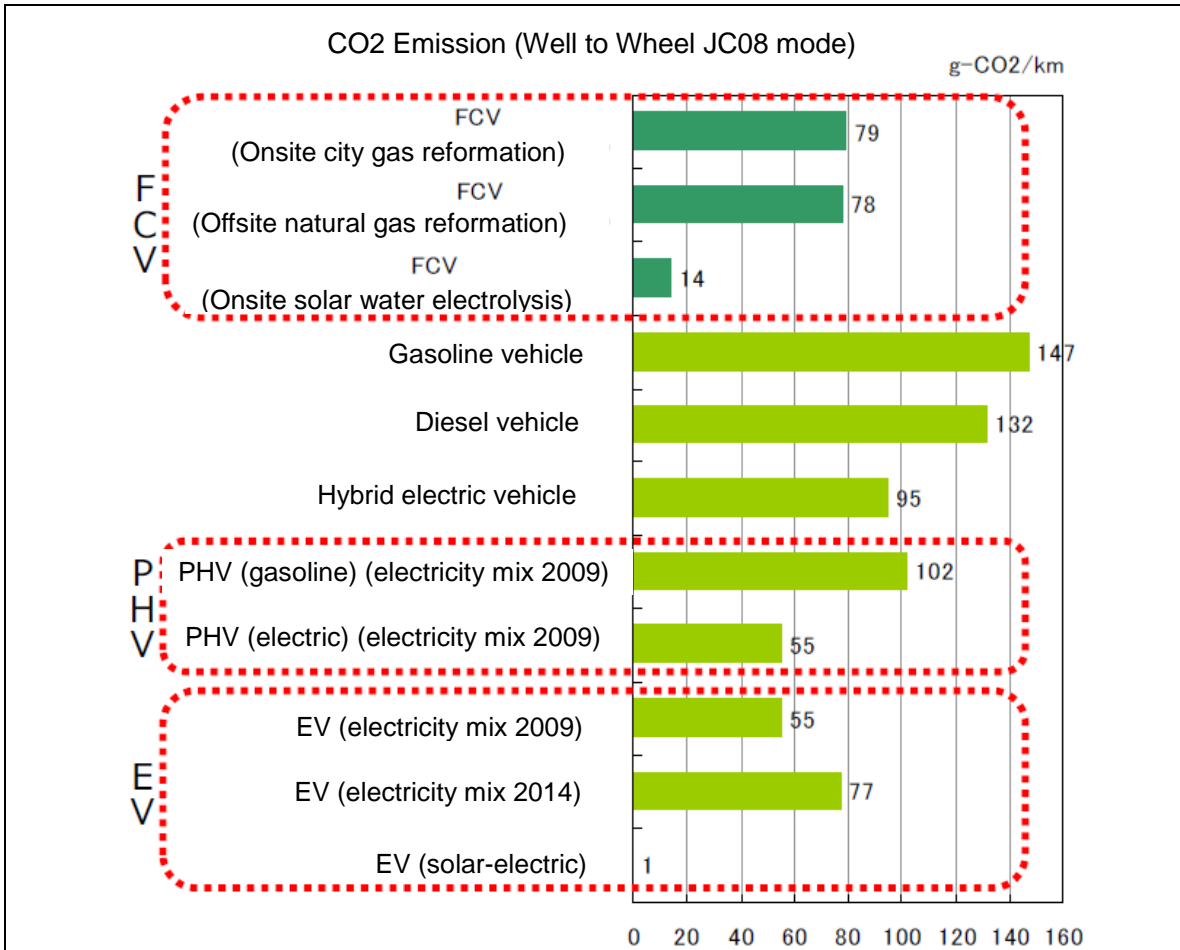

Source: Hydrogen/Fuel-cell strategy roadmap METI, Japan

Comparison of CO₂ emissions between gasoline cars and electrically driven vehicles (Comparison of 1500cc-class vehicles)

Note that EVs using all coal generated electricity can produce emission levels close to that of petrol cars.

Examples of Application

- The introduction of electrically driven vehicles has already begun in some economies in the APEC region, even though it is on a small scale or for experimental purposes. Recently, commercial production of EVs has begun for the use of general public.

HEV PHV EV FCV



Schematic Diagram of the System, etc.

(22) Infrastructure for Electrically Driven Vehicle

Classification of Measures			Low-carbon Measure	Applicability as per Type of Town			
Demand/ Supply	Major Classification	Minor Classification		I	II	III	IV
Demand	Transportation system	Infrastructure for electrically driven vehicles	Charger, Hydrogen filling station	M	M	M	M
Overview of Measures and Applicability							
<ul style="list-style-type: none"> ● Chargers for electric vehicles will be installed taking their usage scenes and driving ranges into account. ● The introduction of chargers and hydrogen filling stations will be promoted by grasping business opportunities, such as city redevelopment projects. ● At the same time, battery technology is improving, so that EVs have longer ranges and are less dependent on charging stations. In the midterm, charging stations may also be used to send excess electricity generated at off-grid buildings into the grid via an EV. 							
Expected CO₂-Reducing Effect							
<ul style="list-style-type: none"> ● Compared to gasoline cars, the driving range of EVs is limited (approximately 160km with one full-charge, but increasing, e.g. Tesla has up to 400 km range), which exerts a significant influence on the sales of EVs. As chargers spread, the diffusion of EV will be boosted, which will, in turn, contribute to the reduction of CO₂ emissions from traffic. ● Hydrogen-filling stations also will boost the diffusion of FCVs. 							
Examples of Application							
<ul style="list-style-type: none"> ● Installation has already started at parking lots, gasoline stations, shopping malls, etc. 							

Schematic Diagram of the System, etc.

- Installation of chargers

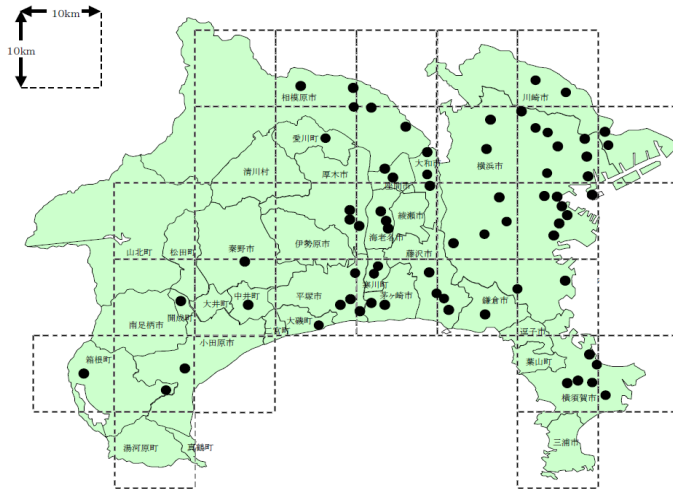

Installation points of fast chargers in Kanagawa Prefecture

Source: Kanagawa Prefectural Government

- Installation of hydrogen-filling station



(23) Community Cycle Sharing

Classification of Measures			Low-carbon Measure	Applicability as per Type of Town			
Demand/ Supply	Major Classification	Minor Classification		I	II	III	IV
Demand	Transportation system	Public transportation systems	Community cycle Sharing	H	H	H	L

Overview of Measures and Applicability

- The community cycle or bike-sharing (hereinafter, the CCS) refers to a system of sharing bicycles where users can pick-drop a bicycle at their convenience. This system aims to increase the use of bicycles as an alternative to cars and address the problems of illegally parked or abandoned bicycles.
- By installing CCS ports around railroad stations and public facilities, this system is expected to take effects to compensate for the unavailability of public transportation infrastructure and to improve accessibility.
- Where bicycle helmets are mandatory (e.g. Australia), operation of CCS can be difficult.

Expected CO₂-Reducing Effect

- With respect to the NUBIJA (the CCS of Changwon city, Korea), about 45% of users in their 30s and older have reportedly switched from cars to bicycles for commuting after one year of the CCS introduction (source: NUBIJA HP). The appropriately introduced CCS will prompt people to switch from automobiles to bicycles, and it is expected to take effect in reducing CO₂ emissions in the transportation sector.

Examples of Application

- There are a number of examples of CCS in cities in the APEC region.



Yokohama City (Japan)



Toyama City (Japan)



Taipei

Schematic Diagram of the System, etc.

- The CCS ports will be installed at railroad stations, public facilities, parks, commercial facilities, office buildings, apartment complexes and so on. Users can pick-drop a bicycle freely. Registration is required. IC cards will be introduced for payment.

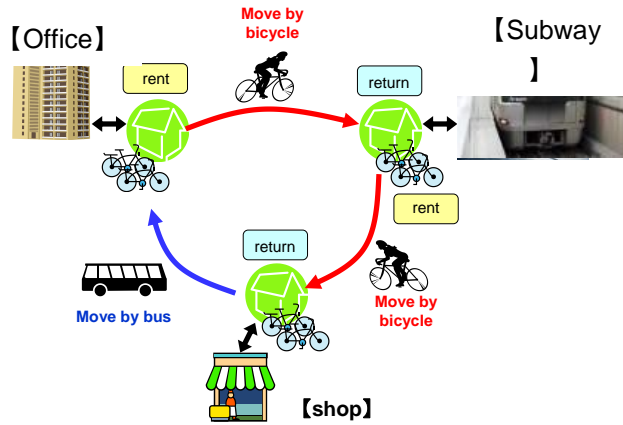

- According to the Japanese experience, bicycles have been used conveniently for approximate 5km trips.

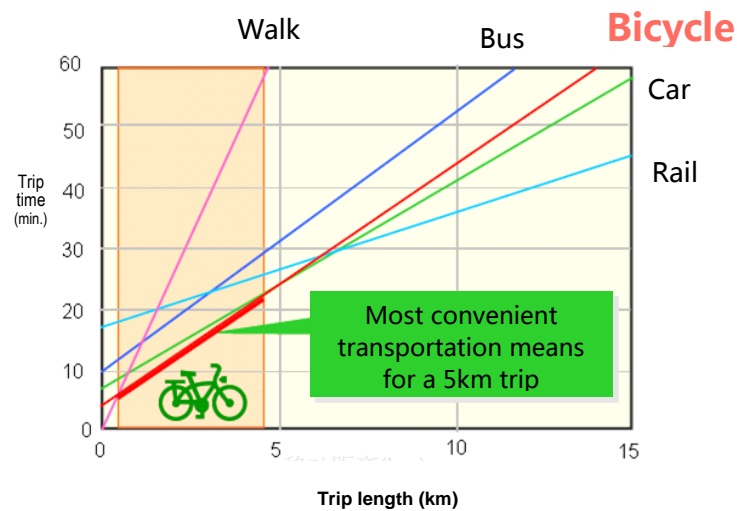

(24) Smart Grid

Classification of Measures			Low-carbon Measure	Applicability as per Type of Town			
Demand/ Supply	Major Classification	Minor Classification		I	II	III	IV
Demand and Supply	Smart grid system and others	Electric power system	Smart grid system	H	H	H	H
Overview of Measures and Applicability							
<ul style="list-style-type: none"> The smart-grid concept is a next-generation power grid in which the electric power flow is controlled flexibly by fully utilising the latest information technologies. It monitors the condition of electricity consumption and generation, balancing demand and supply, at a time when demand and supply will further diversify due to the installation of EV/PHEV, wind power generation, etc. A wide range of information/communications and control technologies are required for the development of smart grids. These include communication technology for advanced metering infrastructure and grid stabilizing technology to mitigate any negative impact on the grid, such as unstable renewable energy. 							
Expected CO₂-Reducing Effect							
<ul style="list-style-type: none"> Expansion of the use of the renewable energy sources and distributed power supply through the system stabilization control. Reduction of the overall emissions of CO₂ from electric power generation. 							
Examples of Application							
<ul style="list-style-type: none"> Kashiwa-no-ha Smart City, Chiba, Japan Woking, UK 							

Schematic Diagram of the System, etc.

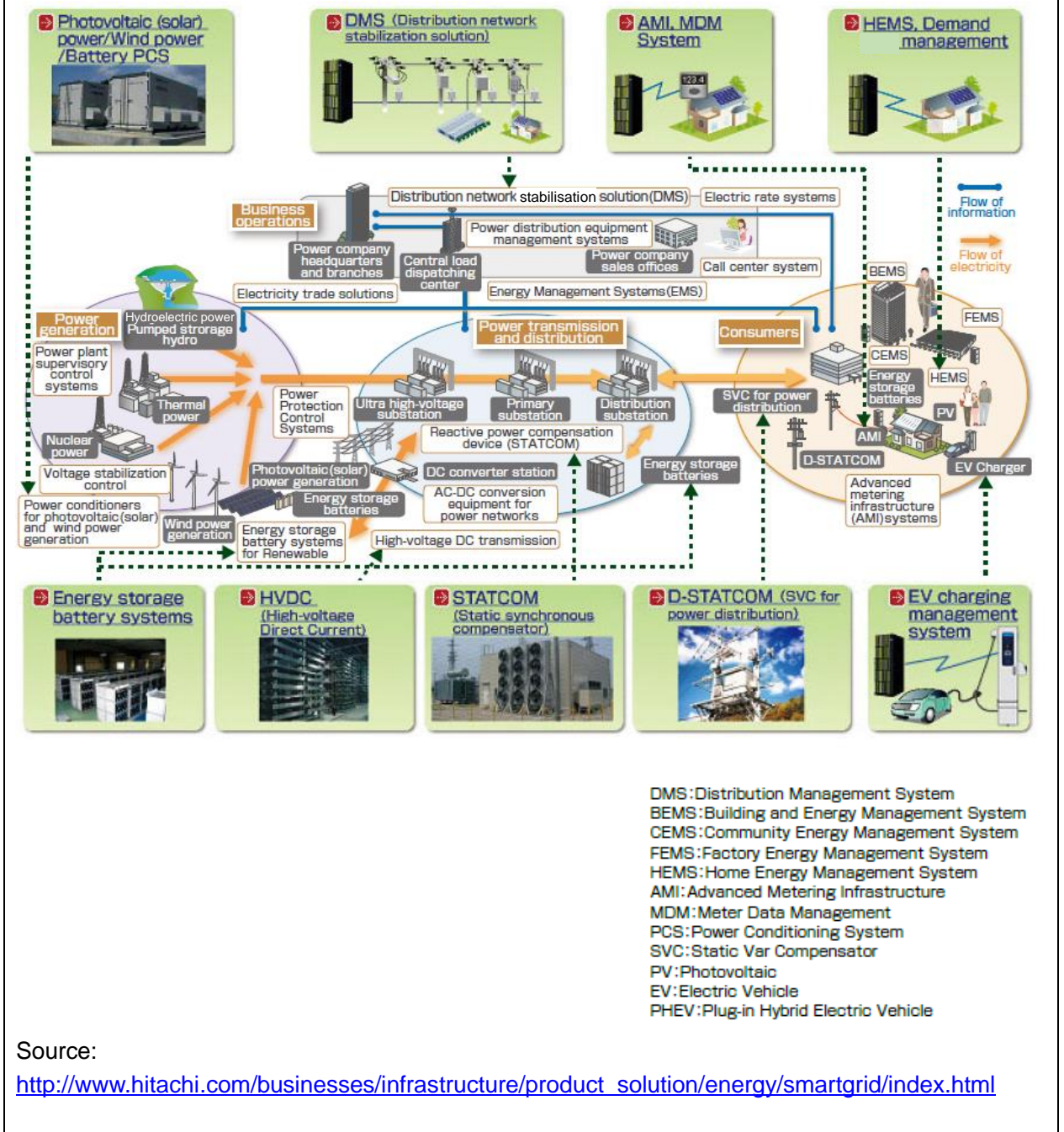

Source:

http://www.hitachi.com/businesses/infrastructure/product_solution/energy/smartgrid/index.html

(25) Garbage

Classification of Measures			Low-carbon Measure	Applicability as per Type of Town			
Demand/ Supply	Major Classification	Minor Classification		I	II	III	IV
Supply	Renewable energy	Biomass power generation	Biogas injection into city gas combustion				
Overview of Measures and Applicability							
<ul style="list-style-type: none"> ● Excessive biogas generated from sewage sludge or food waste is put to an effective onsite use as the fuel for power generation or automobiles. If generated biogas or electricity still remains after onsite use, it would be possible to supply energy (biogas, co-generation power) to the outside. ● These measures not only contribute to energy conservation and CO₂ reduction, but they help make the best use of and recycle local biogas resources, such as sewage sludge or kitchen garbage, for a long-term and in a stable manner. 							
Expected CO₂-Reducing Effect							
<ul style="list-style-type: none"> ● CO₂ can be drastically reduced by using carbon-neutral biogas. ● Avoiding leakage of climate-active methane into the atmosphere offers large emission reduction benefits, as methane is around 25 times as climate-active as the same mass of CO₂. ● (Example) Injection of biogas into city gas conduits: Approx. 1,830 tons/year ● (outlined in below: case example of Tokyo metropolitan area) 							
Examples of Application							
<ul style="list-style-type: none"> ● Biogas generation: Tokyo metropolitan area, Yokohama City, etc. (about 30 sewage treatment facilities, etc.), Japan ● Biogas automobiles: Kobe City, Ueda City, Japan ● Injection of biogas into city gas conduits: Kobe City, Tokyo metropolitan area, Japan 							

Schematic Diagram of the System, etc.

- Example of onsite biogas use (Beer plant)

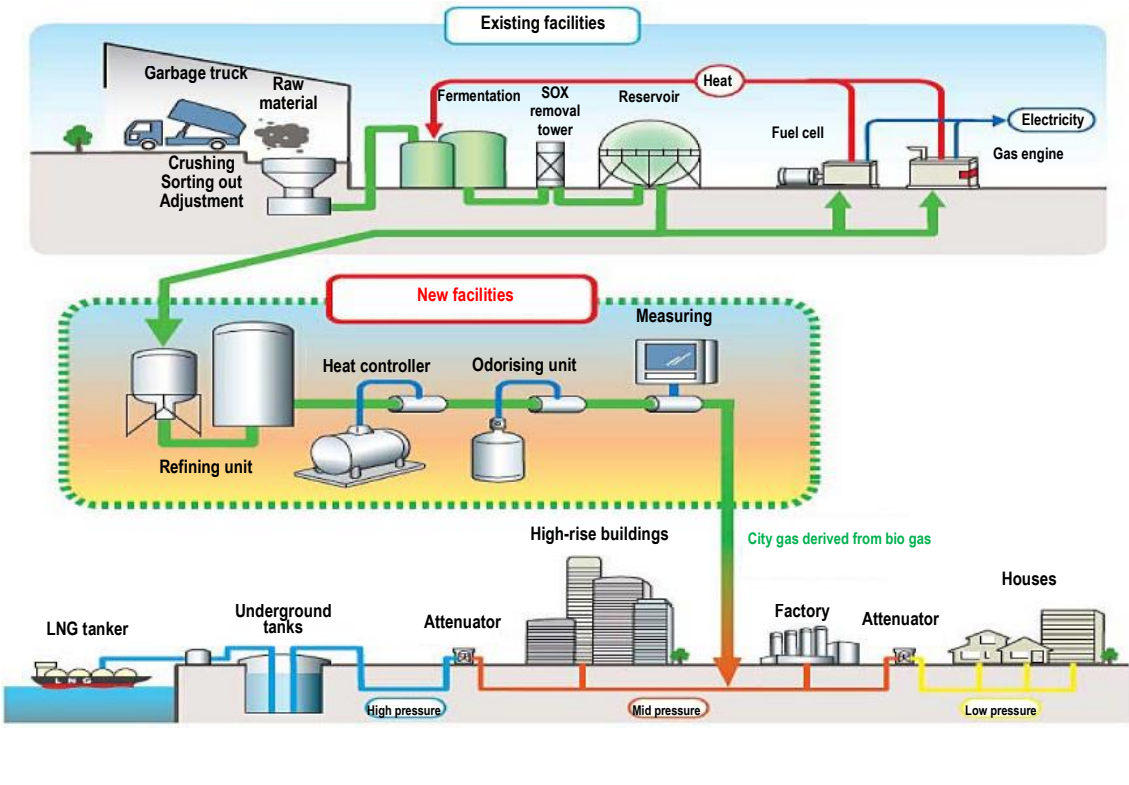
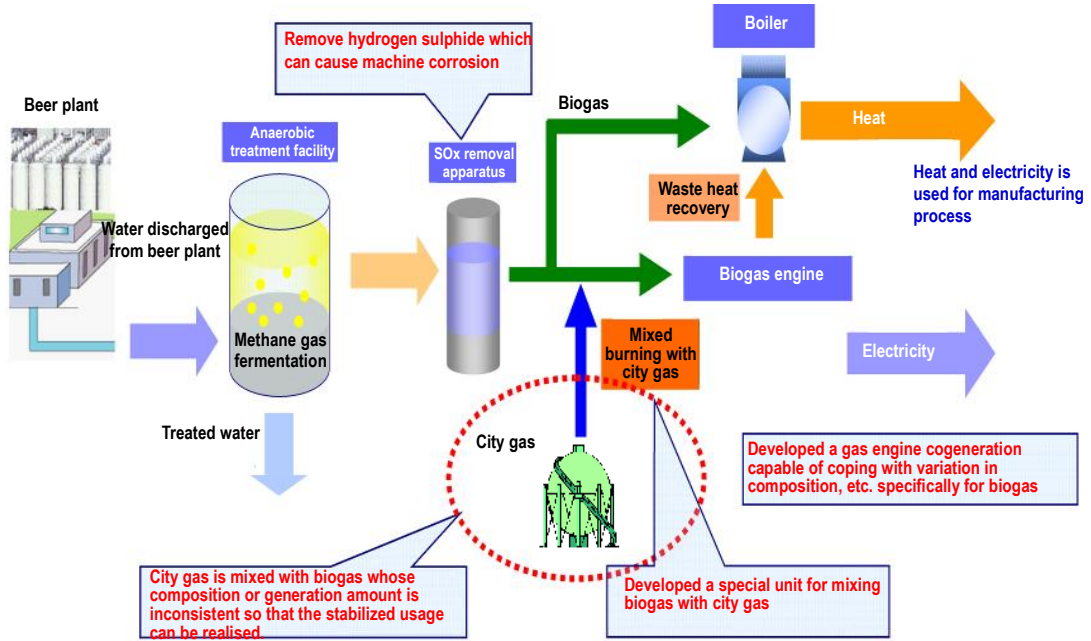

(25) Community Energy Management System

Classification of Measures			Low-carbon Measure	Applicability as per Type of Town			
Demand/ Supply	Major Classification	Minor Classification		I	II	III	IV
Demand and Supply	Energy management system	Area energy management system	Community energy management system (CEMS)	H	H	H	H
Overview of Measures and Applicability							
<ul style="list-style-type: none"> ● Energy management system - autonomous decentralized architecture. ● Realise regional energy management utilising IT. <ul style="list-style-type: none"> ➢ Control storage equipment efficiently by distribution level energy management system (D-EMS) in addition to distribution management system (DMS) to utilise renewable energy. ➢ Realise DSM by providing various services according to the usage situation and contract terms, such as data cooperation with demand (such as EV-EMS, FEMS and HEMS) and provision of supply and demand forecasts and power saving information. 							
Expected CO₂ Reducing Effect							
<ul style="list-style-type: none"> ● Reduction of CO₂ emissions in a neighbourhood through improved energy savings. ● Reduction of CO₂ emissions from the concentrated power supply through the total optimisation of energy consumption and generation in a neighbourhood. 							
Examples of Application							

Schematic Diagram of the System, etc.

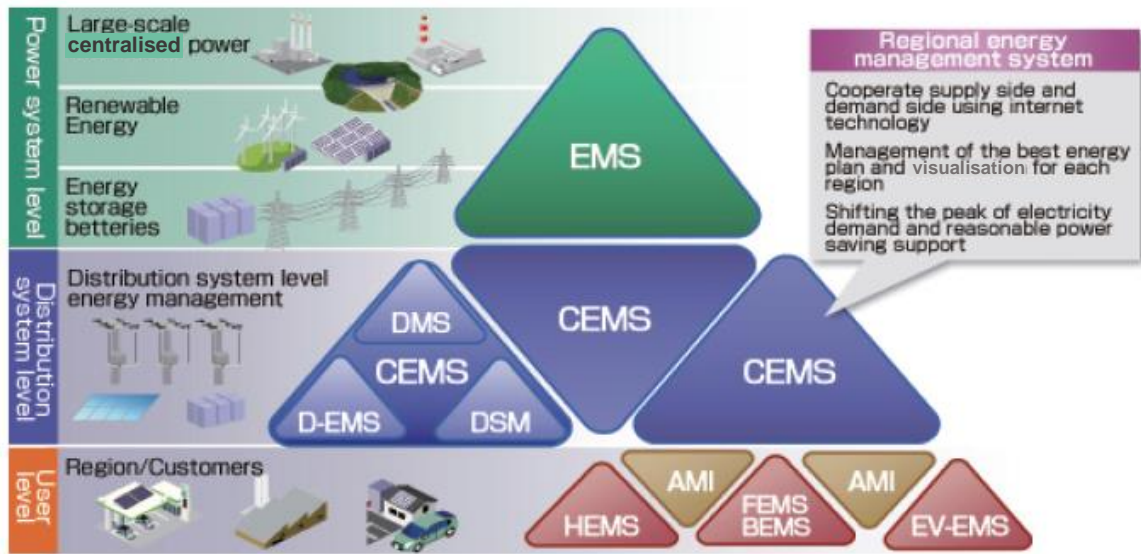

Support minimum energy to keep up life even during an emergency. Introduce each function of CEMS and demand side according to the object function and scale step-by step and partially by autonomous decentralised system.

- AMI: Advanced Metering Infrastructure
- BEMS: Building and Energy Management System
- CEMS: Community Energy Management System
- D-EMS: Distributed Energy Management System
- DMS: Distribution Management System
- DSM: Demand Side Management
- EMS: Energy Management System
- EV-EMS: Electric Vehicle Energy Management System
- FEMS: Factory Energy Management System
- HEMS: Home Energy Management System

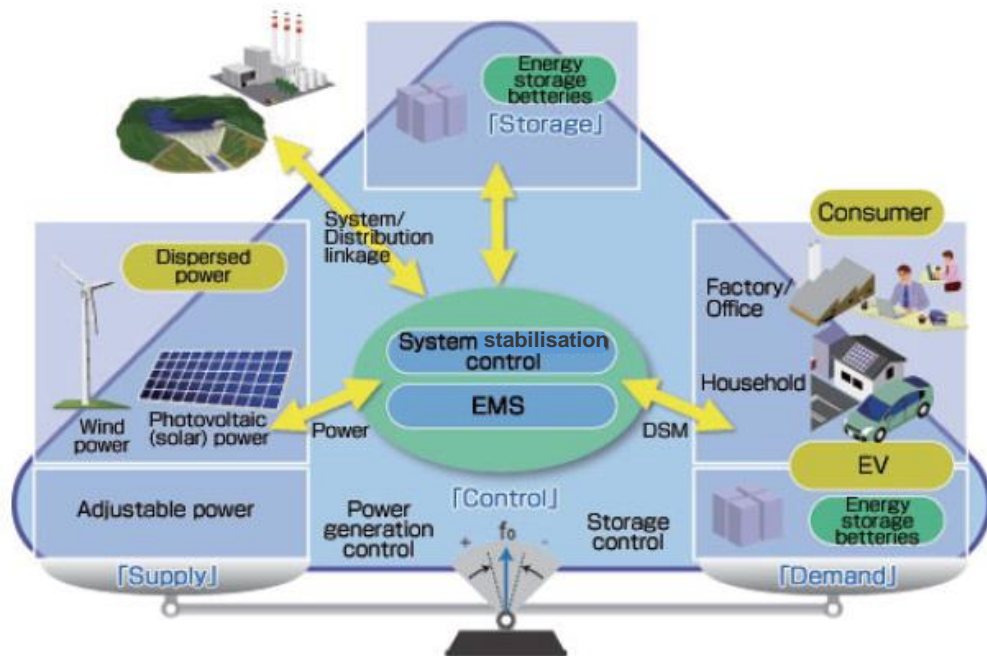

Supply	Traditional power generation such as thermal power and renewable energy (such as photovoltaic (solar) and wind power)
Demand	Home consumers, large scale consumers, such as factories and offices, and EV charging stations which are expected to increase in the future
Storage	The function to mitigate the fluctuation of electricity demand and power output by the energy storage equipments such as storage of electricity and thermal energy.
Control	The whole optimization function by coordinating above three factors with grid stabilizing control, generation control, DSM and power supply control.

Source:

http://www.hitachi.com/businesses/infrastructure/product_solution/energy/smartgrid/promote/management.html

(26) Home Energy Management System

Classification of Measures			Low-carbon Measure	Applicability as per Type of Town			
Demand/ Supply	Major Classification	Minor Classification		I	II	III	IV
Demand and supply	Energy management System	Area energy management system	Home energy management system (HEMS)	H	H	H	H
Overview of Measures and Applicability							
<ul style="list-style-type: none"> ● Utilise renewable energy, such as photovoltaic (solar) power, effectively by controlling load equipment in the home, such as water heaters, storage batteries and EVs. ● Contribute to reducing the regional environment impact by cooperating with community energy management system (CEMS). ● HEMS utilises renewable energy effectively by visualising load equipment information in the home (such as water heater, storage battery and EV) and controlling it properly. ● HEMS contributes to the reasonable peak shifting and load shifting according to the information of supply and demand arrangement request from community energy CEMS. ● Calculates necessary power quantity from demand forecast and output forecast of photovoltaic, and stores in storage batteries and EVs in advance to contribute to maintain minimum energy life in an emergency. ● These systems should be combined with high-efficiency appliances and equipment technologies, such as LED lighting, heat-pump hot water and space conditioning, and high-efficiency TVs, to optimise costs and emission reduction. 							
Expected CO₂-Reducing Effect							
<ul style="list-style-type: none"> ● Optimise home energy use. 							
Examples of Application							

Schematic Diagram of the System, etc.

- Energy Management System

http://www.hitachi.com/businesses/infrastructure/product_solution/energy/smartgrid/promote/management.html

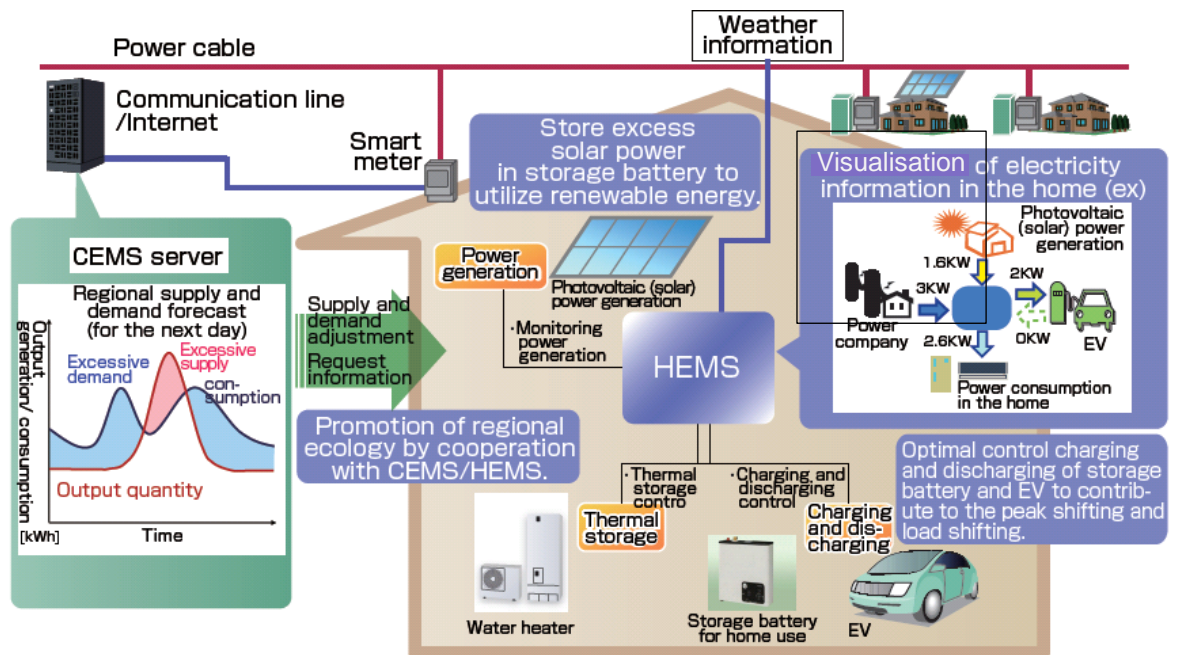

CEMS: Community Energy Management System
 EV: Electric Vehicle
 HEMS: Home Energy Management System

Source:

http://www.hitachi.com/businesses/infrastructure/product_solution/energy/smartgrid/consumer/hems.html

(27) Factory Energy Management System

Classification of Measures			Low-carbon Measure	Applicability as per Type of Town			
Demand/ Supply	Major Classification	Minor Classification		I	II	III	IV
Demand and supply	Energy management system	Area energy management system	Factory energy management system (FEMS)	H	H	H	H
Overview of Measures and Applicability							
<ul style="list-style-type: none"> ● Next-generation energy management system that maximizes the advantage of dispersion cogeneration systems with renewable energy and natural gas energy by managing and controlling both energy supply and consumption in the factory. ● Forecasts variable renewable energy output, power demand and heat demand to realise supply-energy cost reduction and supply stabilisation. ● Realises the improvement in accurate energy demand forecasts by adding production results, production plans and formulation conditions. ● Supports continuous energy saving activity by PDCA cycle and visualising consumption. ● These systems can complement onsite energy recovery, energy-efficiency measures and interaction with neighbouring businesses and the grid. 							
Expected CO₂-Reducing Effect							
<ul style="list-style-type: none"> ● Optimise factory energy use. 							
Examples of Application							

Schematic Diagram of the System, etc.

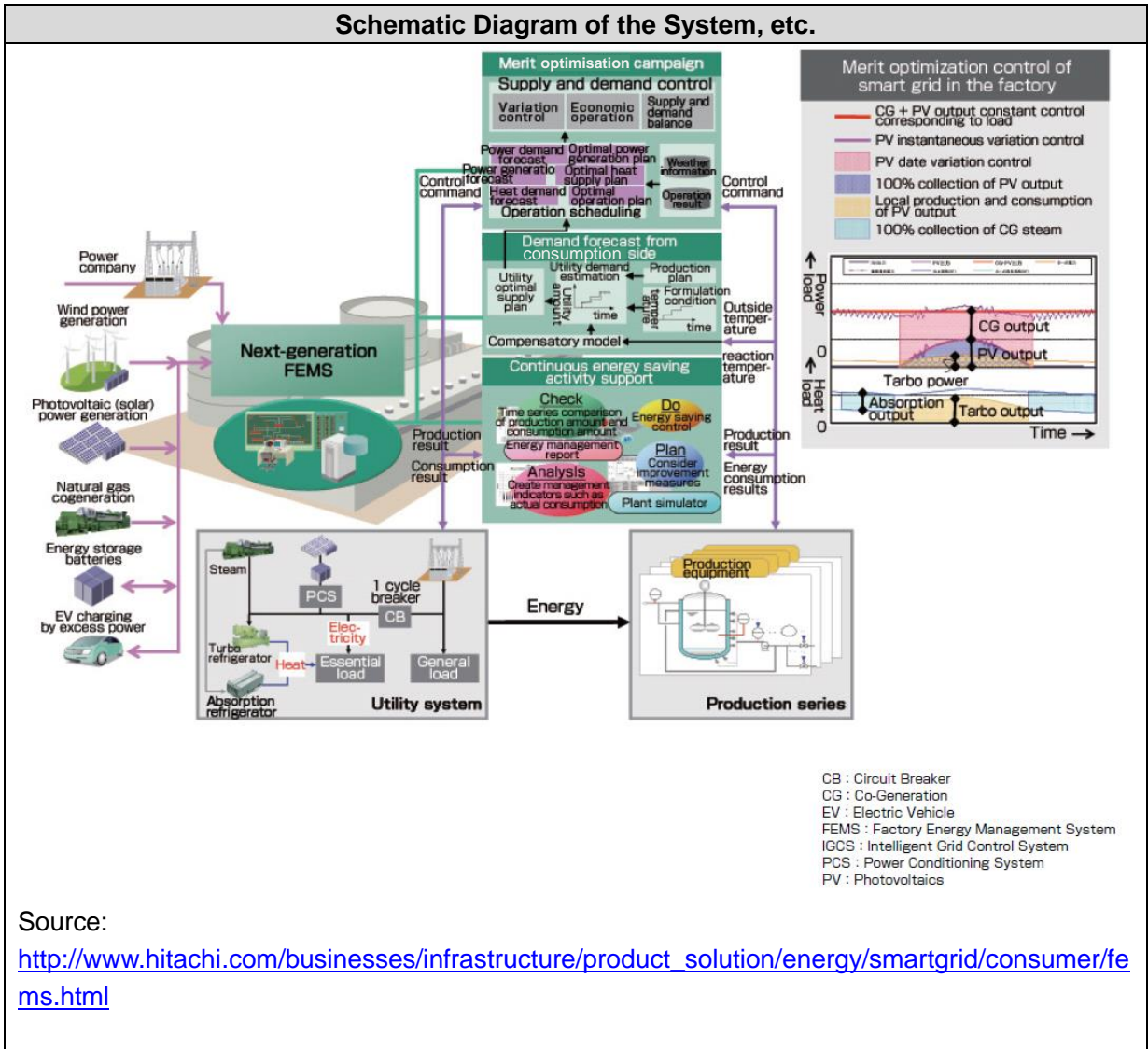

Source:

http://www.hitachi.com/businesses/infrastructure/product_solution/energy/smartgrid/consumer/fe_ms.html

(28) EV Charging Management Solution

Classification of Measures			Low-carbon Measure	Applicability as per Type of Town			
Demand/ Supply	Major Classification	Minor Classification		I	II	III	IV
Demand	Management	Energy management system	EV charging management solution	H	H	H	H
Overview of Measures and Applicability							
<ul style="list-style-type: none"> ● Provides a set of foundation functions, such as user authentication/billing/settlement/monitoring and log collection, which are necessary to operate EV chargers as a necessary service of EV-charging infrastructure. ● Realises EV charging management with the consideration of regional charging station cooperating with the energy management system. ● Charging management solution: <ul style="list-style-type: none"> ➢ Large screen touch panel type service controller performs batch processing of user operation. ➢ Possible to respond to card settlement, car navigation, mobile phone, integration with charger of other maker and shop system cooperation by cooperating with operation/management server. ➢ Adopt OSGi framework for the controller. Provide remote maintenance of the equipment and JAVA middleware environment of which functions can be expanded. ● Cooperation with CEMS and EV-EMS <ul style="list-style-type: none"> ➢ Enable preferential guide to the available charging station and charging with less environment impact by prioritizing effective time zone for renewable energy. 							
Expected CO₂-Reducing Effect							
<ul style="list-style-type: none"> ● Reduction of CO₂ by introducing EVs – the volume of reduction depends on the number of EVs replacing conventional gasoline engine vehicles. ● Combination of EV management system and conventional CEMS further optimise the use of electricity, which, in turn, reduces the emissions of CO₂. 							
Examples of Application							
<ul style="list-style-type: none"> ● Pilot system in Malaga, Spain ● Pilot system in Hawaii, United States ● Pilot system in Okinawa, Japan 							

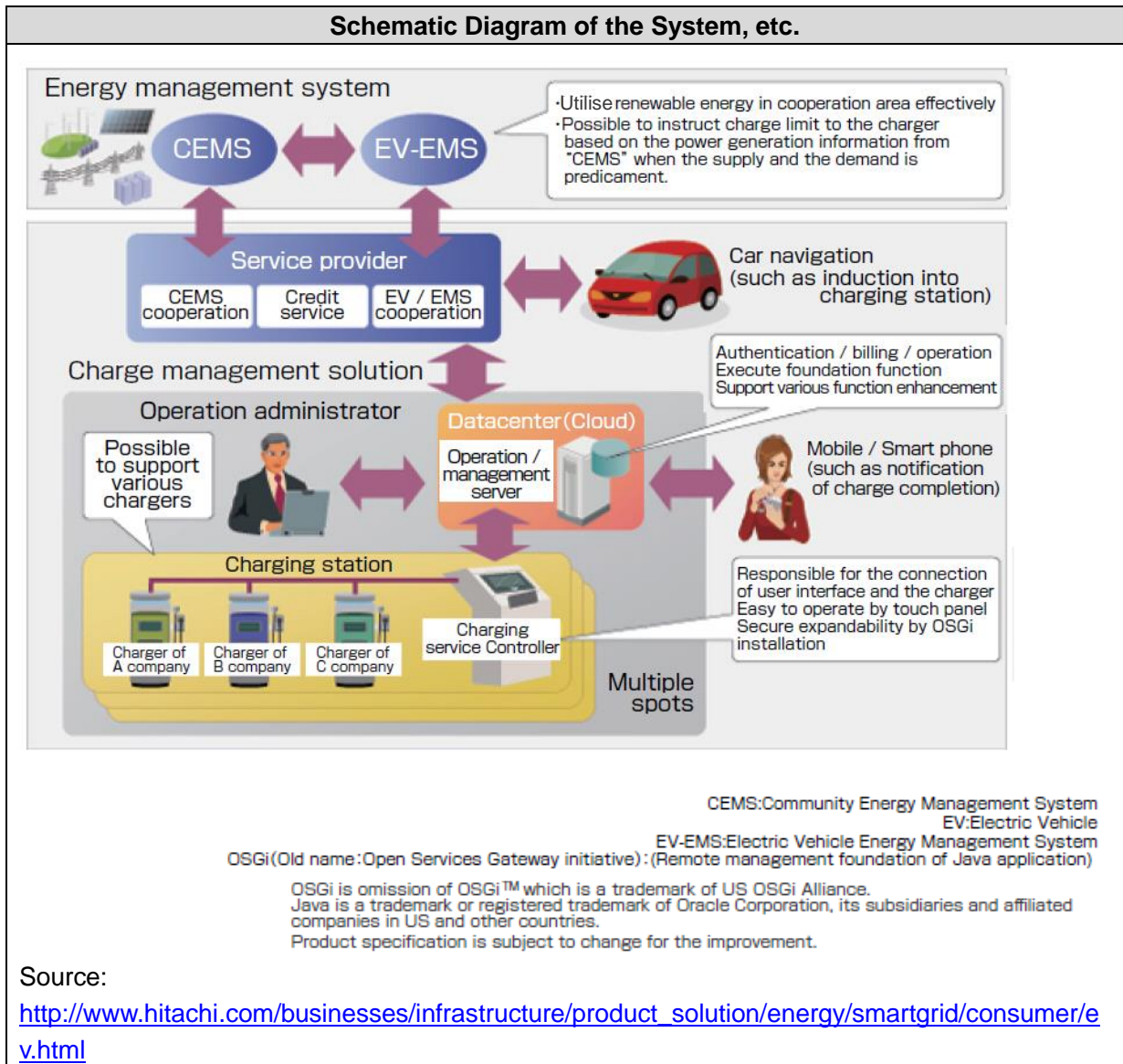

(29) Demand Side Management

Classification of Measures			Low-carbon Measure	Applicability as per Type of Town			
Demand/ Supply	Major Classification	Minor Classification		I	II	III	IV
Demand	Smart grid system (mainly for electric power system)	Network	Demand management	H	H	H	H
Overview of Measures and Applicability							
<ul style="list-style-type: none"> ● Coordinate the data with demand (such as HEMS) to provide supply and demand forecasts and power saving information, including diagnosis of issues, feedback to users, correction of problems, interaction with the grid for pricing, supply reliability, and optimising energy exports. ● Realise the reasonable peak decreasing and peak shifting by providing various services according to the usage situation and contract terms. ● Forecast precisely the power supply and demand plan and the power demand of the next day by utilising current supply capacity, past demand results and weather information. ● Request power saving and recommend shifting time of power using to out of peak time to consumers. ● Possible to provide various services such as offering incentive according to the precise load power using state. 							
Expected CO ₂ -Reducing Effect							
<ul style="list-style-type: none"> ● Contribute to the utilisation of renewable energy and reasonable power saving 							
Examples of Application							

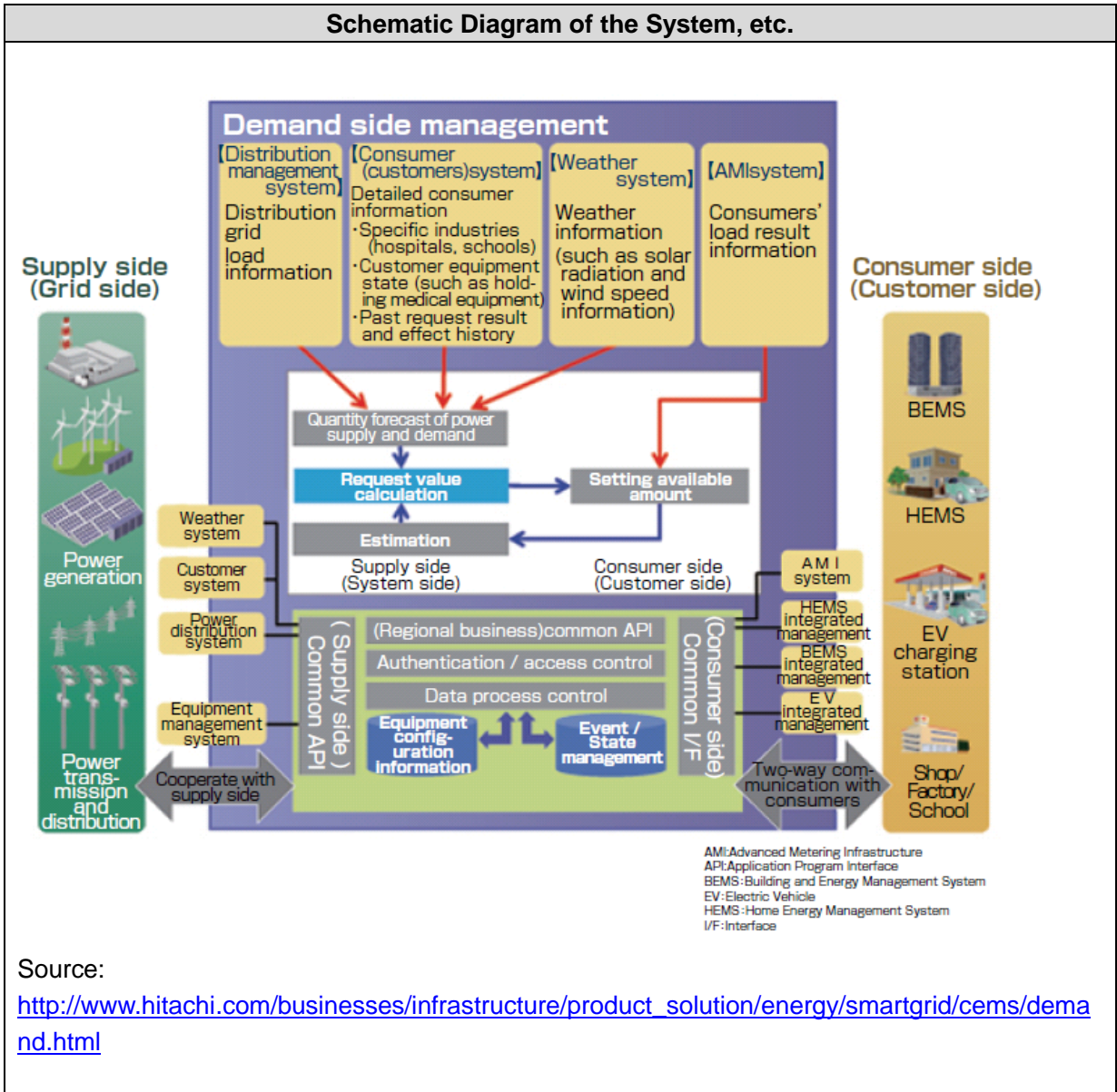

(30) Simulation Results for CO₂ Emission Reduction (Central TOKYO 7 Wards Area)

Classification of Measures			Low-carbon Measure	Applicability as per Type of Town			
Demand/ Supply	Major Classification	Minor Classification		I	II	III	IV
Demand	Building	Low-carbon building	Reducing heat loads				
Overview of Measures and Applicability							
<ul style="list-style-type: none"> ● Tokyo Prefecture Environmental Agency made a 2-year demonstration project from 2007 to 2008 estimating the CO₂-emission reduction when the building roof top was covered by green planting or cool-roof paint. ● The CO₂ emission reduction weights (kg –CO₂/year · m²) for green planting or cool-roof paint were investigated for specific buildings preceded by the demonstration project. ● CO₂ emission rate (kg –CO₂/year · m²) were estimated as Table-1. 							
Expected CO₂-Reducing Effect							
Table-1 CO₂ Emission Reduction (kg –CO₂/year · m²)							
Type of roof top	CO ₂ -emission reduction		CO ₂ -emission reduction (Life cycle cost added)				
Green planting	5.218		4.167				
Cool-roof paint	1.919		1.873				
Insulation thickness 25mm							
Table-2 CO₂ Emission Reduction in 2-years Demonstration Project							
Type of roof top	Constructed area m ²	CO ₂ -emission reduction Tone-CO ₂ / year					
Green planting	6,458.8	33.7					
Cool-roof paint	29,175.1	56.0					

Table-3 Expected Roof Top Area for CO₂ Reduction (Central TOKYO 7 Wards Area)

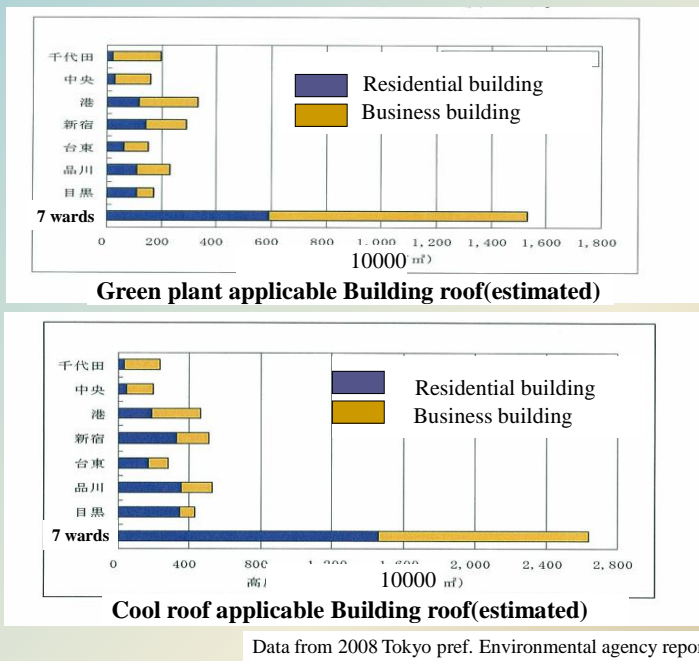

- At the stage of 50% adoption, 25,307 tonnes of CO₂-emission reduction can be expected for cool-roof paint.

Table-4 CO₂ Gas Reduction (T/year) VS Two Measures Adoption Rate

・ CO₂ Gas reduction (T/year) VS Two measures adoption rate

Adoption rate Method	Trial period (%) 0.04 0.11	3%	10%	30%	50%
		Green planting Roof	33.7	2,395	7,983
Coolroof paint	56.0	1,518	5,061	1,5184	25,307

t / year (-CO₂)

Data from 2008 Tokyo pref. Environmental agency report

Examples of Application

- Central TOKYO 7 wards area (Chiyoda-ku, Chuo-ku, Minato-ku, Shinjuku-ku, Taitoh-ku, Shinagawa-ku, and Meguro-ku), Japan

Schematic Diagram of the System, etc.

APEC Project: EWG 01 2015A
APEC Low-Carbon Model Town (LCMT) Project - Phase 6

Produced by
APEC Low-Carbon Model Town Task Force

Katsushi Takehiro
Ministry of Economy, Trade and Industry, Japan

Asia Pacific Energy Research Centre
Inui Building, Kachidoki, 1-13-1, Kachidoki,
Chuo-ku, Tokyo, 104-0054, Japan
Phone: (+81) 3-5144-8551
E-mail: master@aperc.iecej.or.jp
Website: <http://aperc.iecej.or.jp>

For
Asia Pacific Economic Cooperation Secretariat
35 Heng Mui Keng Terrace, Singapore 119616
Phone: (65) 6891-9600
E-mail: info@appec.org
Website: <http://www.appec.org>

© 2016 APEC Secretariat

APEC#216-RE-01.27